



Operating Instructions interferoMETER

IMS5420-TH24
IMS5420MP-TH24
IMS5420IP67-TH24

MICRO-EPSILON
MESSTECHNIK
GmbH & Co. KG
Koenigbacher Str. 15

94496 Ortenburg / Germany

Tel. +49 (0) 8542 / 168-0
Fax +49 (0) 8542 / 168-90
e-mail info@micro-epsilon.com
www.micro-epsilon.com



EtherCAT® is registered trademark and patented technology,
licensed by Beckhoff Automation GmbH, Germany.

Contents

1.	Safety	9
1.1	Symbols Used	9
1.2	Warnings	9
1.3	Notes on Product Marking	9
1.3.1	CE Marking	9
1.3.2	UKCA Marking	10
1.4	Intended Use	10
1.5	Proper Environment	10
2.	Laser Class	11
3.	Functional Principle, Technical Data	12
3.1	Short Description	12
3.2	Measuring Principle	12
3.3	Term Definitions	13
3.4	Operating Modes	13
3.5	Sensors	13
3.6	Technical Data IMS5420	14
4.	Delivery	16
4.1	Unpacking/Included in Delivery	16
4.2	Storage	16
5.	Installation	17
5.1	IMC5420 and IMC5420MP Controller	17
5.2	IMC5420IP67-TH24 Controller	18
5.3	IMC5420 and IMC5420MP Controller Operating Elements	19
5.4	IMC5420IP67-TH24 Controller Operating Elements	19
5.5	LEDs IMC5420 and IMC5420MP Controller	20
5.6	LED IMC5420IP67 Controller	20
5.7	Electrical Connections IMC5420 and IMC5420MP Controller	21
5.7.1	Connection Possibilities	21
5.7.2	Handling of Pluggable Screw Terminals	21
5.7.3	Grounding, Shielding	21
5.7.4	Supply Voltage (Power)	22
5.7.5	RS422	22
5.7.6	Ethernet, EtherCAT	22
5.7.7	Analog Output	23
5.7.8	Switching Outputs (Digital I/O)	24
5.7.9	Synchronization (Inputs/Outputs)	25
5.7.10	Triggering	26
5.7.11	Encoder Inputs	27
5.8	Electrical Connections IMC5420IP67-TH24 Controller	28
5.8.1	Connection Possibilities	28
5.8.2	Grounding, Shielding	28
5.8.3	Supply Voltage (Power)	29
5.8.4	RS422	29
5.8.5	Ethernet	29
5.9	Sensor Cable	30
5.10	Sensors	32
5.10.1	Sensor Dimensions	32
5.10.2	Start of Measuring Range	32
5.10.3	Mounting, Mounting Adapter	33
6.	Operation	34
6.1	Initial Operation	34
6.2	Control via Ethernet	34
6.2.1	Requirements	34
6.2.2	Access via Web Interface	35
6.3	Select a Sensor	36
6.4	Button Multifunction	36
6.5	Positioning the Target, Thickness Measurement	37
6.6	Presets, Setups, Measurement Configuration, Signal Quality	38
6.7	FFT Signal	40
6.8	Thickness Measurement with Web Page Display	42
6.9	Load / Save Settings	44
7.	Advanced Settings	45
7.1	Inputs	45
7.1.1	Synchronization	45
7.1.2	Encoder	45
7.1.3	Key Function	45
7.1.4	Input Level	45
7.1.5	Termination	45
7.2	Data Recording	46
7.2.1	Measuring Rate	46
7.2.2	Masking the Evaluation Range	47
7.2.3	Exposure Mode	47
7.2.4	Detection Threshold	48

7.2.5	Measpeak Sorting	48
7.2.6	Number of Peaks	50
7.2.7	Material Selection	52
7.2.8	Triggering.....	54
7.2.8.1	General.....	54
7.2.8.2	Triggering Data Recording	55
7.2.8.3	Triggering Data Output	55
7.2.8.4	Trigger Time Difference.....	55
7.3	Signal Processing, Calculation.....	56
7.3.1	Data Source, Parameter, Programs	56
7.3.2	Definitions	57
7.3.3	Measurement Averaging	58
7.3.3.1	Moving average	58
7.3.3.2	Recursive average	59
7.3.3.3	Median	60
7.4	Postprocessing	61
7.4.1	Zeroing, Mastering	61
7.4.2	Statistics	62
7.4.3	Data Reduction, Output Data Rate.....	63
7.4.4	Error Handling (Hold Last Value)	63
7.5	Outputs	64
7.5.1	General	64
7.5.2	RS422	64
7.5.3	Data Output Ethernet.....	64
7.5.4	Analog Output	65
7.5.4.1	Calculation of the Measurement Value at the Current Output	66
7.5.4.2	Calculation of the Measurement Value at the Voltage Output	66
7.5.5	Digital Outputs, Limit Value Monitoring.....	67
7.5.6	Data Output, Interface Selection	67
7.5.7	Ethernet Settings	68
7.6	System settings	69
7.6.1	Unit Website.....	69
7.6.2	Language Support.....	69
7.6.3	Key Lock	69
7.6.4	Load and Safe	69
7.6.5	Import, Export.....	70
7.6.6	Access Authorization	71
7.6.7	Reset Controller.....	72
7.6.8	Light Source	72
7.6.9	Material Table.....	72
7.6.10	Switching between Ethernet and EtherCAT	72
8.	Thickness Measurement.....	73
8.1	Requirements.....	73
8.2	Sensor Selection.....	73
8.3	Material Selection	73
8.4	FFT Signal.....	74
8.4.1	Measurement Chart.....	74
9.	Disclaimer	75
10.	Service, Repair	75
11.	Decommissioning, Disposal	75
	Appendix.....	76
A 1	Accessories, Services.....	76
A 2	Factory Settings	77
A 3	ASCII Communication with Controller	78
A 3.1	General	78
A 3.2	Commands Overview	78
A 3.3	General Commands	81
A 3.3.1	General	81
A 3.3.1.1	Help	81
A 3.3.1.2	Controller Information	81
A 3.3.1.3	Reply type	81
A 3.3.1.4	Parameter Overview	81
A 3.3.1.5	Synchronization	82
A 3.3.1.6	Termination Resistor at Sync/Trig Input.....	82
A 3.3.1.7	Bootting the Controller	82
A 3.3.1.8	Reset Counter	82
A 3.3.2	User Level.....	83
A 3.3.2.1	Changing the User Level	83
A 3.3.2.2	Changing to User Level	83
A 3.3.2.3	Querying the User Level	83
A 3.3.2.4	Defining a Standard User	83
A 3.3.2.5	Changing the Password	83

A 3.3.3	Sensor	84
	A 3.3.3.1 Info about Calibration Tables	84
	A 3.3.3.2 Sensor Number	84
	A 3.3.3.3 Sensor Information	84
	A 3.3.3.4 Pilot Laser	84
	A 3.3.3.5 SLED	84
A 3.3.4	Triggering	85
	A 3.3.4.1 Select Trigger Source	85
	A 3.3.4.2 Output of Triggered Values, With/Without Averaging	85
	A 3.3.4.3 Trigger Type	85
	A 3.3.4.4 Active Level Trigger Input	85
	A 3.3.4.5 Software Trigger Pulse	85
	A 3.3.4.6 Number of Output Measurement Values	85
	A 3.3.4.7 Trigger Level TriglN	85
	A 3.3.4.8 Maximum Encoder Triggering	86
	A 3.3.4.9 Minimum Encoder Triggering	86
	A 3.3.4.10 Step Size Encoder Triggering	86
	A 3.3.4.11 Example	86
A 3.3.5	Encoder	87
	A 3.3.5.1 Encoder Interpolation Depth	87
	A 3.3.5.2 Effect of the Reference Track	87
	A 3.3.5.3 Encoder Value	87
	A 3.3.5.4 Setting Encoder Value per Software	87
	A 3.3.5.5 Reset the Detection of the First Marker Position	87
	A 3.3.5.6 Maximum Encoder Value	87
	A 3.3.5.7 Encoder3 On/Off	87
A 3.3.6	Interfaces	88
	A 3.3.6.1 Ethernet IP Settings	88
	A 3.3.6.2 Setting for Ethernet Transmission of Measured Values	88
	A 3.3.6.3 Setting the RS422 Baud Rate	88
	A 3.3.6.4 Change Ethernet / EtherCAT	88
	A 3.3.6.5 Measurements per frame	88
	A 3.3.6.6 TCP On/Off	88
A 3.3.7	Parameter Management, Load / Save Settings	89
	A 3.3.7.1 Safe / Load Connection Settings	89
	A 3.3.7.2 Show Changed Parameters	89
	A 3.3.7.3 Export of Parameter Sets to PC	89
	A 3.3.7.4 Import of Parameter Sets from PC	89
	A 3.3.7.5 Default Settings	89
	A 3.3.7.6 Editing, Storing, Displaying, Deleting Measurement Settings	90
A 3.3.8	Measurement	91
	A 3.3.8.1 Measuring Rate	91
	A 3.3.8.2 Masking the Evaluation Ranges	91
	A 3.3.8.3 Peak Detection Threshold	91
A 3.3.9	Material Data Base	92
	A 3.3.9.1 Material Table	92
	A 3.3.9.2 Select Material	92
	A 3.3.9.3 Display Material Properties	92
	A 3.3.9.4 Edit Material Table	92
	A 3.3.9.5 Material ergänzen	92
	A 3.3.9.6 Determining the Material Composition of the Target	92
	A 3.3.9.7 Defining a Medium in Front of the Target	93
	A 3.3.9.8 Delete a Material	93
	A 3.3.9.9 Number of Peaks	93
A 3.3.10	Measurement Value Processing	93
	A 3.3.10.1 List of Possible Thickness Signals for Statistical Calculation	93
	A 3.3.10.2 Generate Statistic Signals	93
	A 3.3.10.3 List of Statistical Signals	93
	A 3.3.10.4 Reset Statistical Calculation	93
	A 3.3.10.5 Statistics Example	94
	A 3.3.10.6 List of Signals which can be Parameterized	95
	A 3.3.10.7 Master Signal Parameterization	95
	A 3.3.10.8 List of Possible Signals for Mastering	95
	A 3.3.10.9 Masters / Zero	95
	A 3.3.10.10 Mastering Example	95
	A 3.3.10.11 Channel Computation	97
	A 3.3.10.12 List of possible calculation signals	97
A 3.3.11	Data Output	98
	A 3.3.11.1 Selection of Digital Output	98
	A 3.3.11.2 Data Output Rate	98
	A 3.3.11.3 Reduction Counter of Measurement Value Output	98
	A 3.3.11.4 Error Processing	98
A 3.3.12	Select Measurement Values to be Output	99
	A 3.3.12.1 General	99
	A 3.3.12.2 Data Selection of Ethernet	99
	A 3.3.12.3 List of Possible Ethernet Signals	99
	A 3.3.12.4 List of Selected Signals, Transfer Sequence via Ethernet	99
A 3.3.13	Switching Outputs	100
	A 3.3.13.1 Error Switching Outputs	100
	A 3.3.13.2 Setting the Signal to be Evaluated	100
	A 3.3.13.3 List of Possible Signals for Error Output	100
	A 3.3.13.4 Setting Limit Values	100
	A 3.3.13.5 Setting Value	100
	A 3.3.13.6 Switching Behavior for Error Outputs	100

A 3.3.14	Analog Output	101
A 3.3.14.1	Data Selection	101
A 3.3.14.2	List of Possible Signals for Analog Output	101
A 3.3.14.3	Output Range	101
A 3.3.14.4	Setting the Scaling of DAC	101
A 3.3.14.5	Setting the Scaling Range	101
A 3.3.15	Key Functions	102
A 3.3.15.1	Multifunction Button	102
A 3.3.15.2	Signal Selection for Mastering with Multifunction Button	102
A 3.3.15.3	Key Lock	102
A 3.4	Measured Value Format	103
A 3.4.1	Structure	103
A 3.4.2	Exposure Time	103
A 3.4.3	Encoder	103
A 3.4.4	Measured Value Counter	103
A 3.4.5	Time Stamp	103
A 3.4.6	Measurement Data (displacements and signal quality)	104
A 3.4.7	Trigger Time Difference	104
A 3.4.8	Statistical values	104
A 3.5	Measurement Data Format	105
A 3.5.1	Measurement Data transmission to a Server via Ethernet	105
A 3.5.1.1	General	105
A 3.5.1.2	Measurement Frame	106
A 3.5.1.3	State Word	106
A 3.5.1.4	Example	106
A 3.5.1.5	Error Codes Ethernet Interface	107
A 3.5.2	Ethernet FFT Signal Transmission	107
A 3.6	Warning and Error Messages	107
A 4	EtherCAT Documentation	109
A 4.1	General	109
A 4.2	Switching between Ethernet and EtherCAT	109
A 4.3	Introduction	110
A 4.3.1	Structure of EtherCAT® Frames	110
A 4.3.2	EtherCAT® Services	110
A 4.3.3	Addressing and FMMUs	111
A 4.3.4	Sync Managers	111
A 4.3.5	EtherCAT State Machine	111
A 4.3.6	CANopen over EtherCAT	112
A 4.3.7	Process Data Object Mapping (PDO Mapping)	112
A 4.3.8	Service Data SDO Service	112
A 4.4	CoE Object Directory	113
A 4.4.1	Communication-Specific Standard Objects	113
A 4.4.1.1	Overview	113
A 4.4.1.2	Object 1000h: Device Type	113
A 4.4.1.3	Object 1008h: Manufacturer's Device Name	113
A 4.4.1.4	Object 1009h: Hardware Version	113
A 4.4.1.5	Object 100Ah: Software Version	113
A 4.4.1.6	Object 1018h: Device Identification	113
A 4.4.1.7	TxPDO Mapping	114
A 4.4.1.8	Object 1C00h: Type of Synchronization Manager	115
A 4.4.1.9	Object 1C12h: RxPDO Assign	115
A 4.4.1.10	Object 1C13h: TxPDO Assign	115
A 4.4.1.11	Object 1C33h: Synchronization Manager Input Parameters	116
A 4.4.2	Manufacturer-Specific Objects	117
A 4.4.2.1	Overview	117
A 4.4.2.2	Object 2001h: User Level	118
A 4.4.2.3	Object 2005h: Controller Info (continued)	118
A 4.4.2.4	Objekt 2020h: Load, Save, Factory Settings	118
A 4.4.2.5	Objekt 2021h: Preset	119
A 4.4.2.6	Objekt 2022h: Measurement Settings	119
A 4.4.2.7	Object 203Fh: Sensor Error	119
A 4.4.2.8	Object 2101h: Reset	120
A 4.4.2.9	Object 2105h: Factory Settings	120
A 4.4.2.10	Object 2107h: Reset Counter	120
A 4.4.2.11	Object 2133h: SLED Light Source	120
A 4.4.2.12	Object 2134h: Pilot Laser	120
A 4.4.2.13	Object 2141h: Request FFT Signal	120
A 4.4.2.14	Object 2142h: Share FFT Signal	120
A 4.4.2.15	Object 2150h: Sensor	120
A 4.4.2.16	Object 2152h: Sensor Selection	121
A 4.4.2.17	Objekt 2156h: Number of Peaks for Multilayer Materials	121
A 4.4.2.18	Object 2162h: Peak Options	121
A 4.4.2.19	Object 2162h: Peak Selection	121
A 4.4.2.20	Object 21B0h: Digital Interfaces	121
A 4.4.2.21	Object 21B1h: Select Interface	121
A 4.4.2.22	Object 21C0h: Ethernet	122
A 4.4.2.23	Objekt 21D0h: Analog Output	122
A 4.4.2.24	Object 21F3h: Switching Output 1	123
A 4.4.2.25	Object 2251h: Measuring Rate	123
A 4.4.2.26	Object 24A0h: Keylock	123
A 4.4.2.27	Object 24A2h: Multifunction Button	124
A 4.4.2.28	Object 25A0h: Encoder	124
A 4.4.2.29	Object 25A1: Encoder3	125

A 4.4.2.30	Object 2711h: Masking the Evaluation Range	125
A 4.4.2.31	Objekt 2800h: Material Information	125
A 4.4.2.32	Object 2802h: Edit Material Table	125
A 4.4.2.33	Object 2803h: Existing Materials	126
A 4.4.2.34	Object 2804h: Select Material.....	126
A 4.4.2.35	Objekt 2805h: Material between Sensor and 1st Layer	126
A 4.4.2.36	Object 2A00h: Mastering	126
A 4.4.2.37	Object 2A10h: Statistics.....	127
A 4.4.2.38	Object 2C00h: Measured Value Calculation	128
A 4.4.2.39	Object 2E00: User Signals.....	129
A 4.5	Mappable objects – process data	130
A 4.6	Error codes for SDO services	131
A 4.7	Oversampling.....	132
A 4.8	Calculation	133
A 4.9	Operational Modes	133
A 4.9.1	Free Run	133
A 4.9.2	Distributed Clocks SYNC0 Synchronization	133
A 4.10	FFT Signal via SDO	133
A 4.11	STATUS LEDs in EtherCAT Operation	134
A 4.12	EtherCAT Configuration with the Beckhoff TwinCAT® Manager	135
A 5	Data Format RS422	138
A 5.1	Bit Structure	138
A 5.2	Description.....	138
A 5.3	Examples	139
A 6	Telnet.....	141
A 6.1	General	141
A 6.2	Connection establishment.....	141
A 6.3	Error Messages.....	141

1. Safety

System operation assumes knowledge of the operating instructions.

1.1 Symbols Used

The following symbols are used in these operating instructions:



Indicates a hazardous situation which, if not avoided, may result in minor or moderate injuries.



Indicates a situation which, if not avoided, may lead to property damage.



Indicates a user action.



Indicates a user tip.

Measure

Indicates a hardware or a button/menu in the software.

1.2 Warnings



Avoid unnecessary laser radiation to be exposed to the human body.



Switch off the controller for cleaning and maintenance.



Switch off the controller for system maintenance and repair if the controller is integrated into a system.

Caution - use of controls or adjustments or performance of procedures other than those specified may cause harm.

Connect the power supply and the display/output device according to the safety regulations for electrical equipment.

> Risk of injury

> Damage to or destruction of the controller



The supply voltage must not exceed the specified limits.

> Damage to or destruction of the controller

Avoid shocks and impacts to the sensor and controller.

> Damage to or destruction of the components

Never fold the fiber optics and do not bend them in tight radii.

> Damage to or destruction of the optical fibers; failure of measuring device

Protect the ends of the optical fibers against contamination. Use protective caps.

> Failure of the measuring device

Protect the cable against damage.

> Failure of the measuring device

1.3 Notes on Product Marking

1.3.1 CE Marking

The following apply to the interferoMETER IMS5420:

- EU Directive 2014/30/EU,
- EU Directive 2011/65/EU

Products which carry the CE mark satisfy the requirements of the EU directives cited and the relevant applicable harmonized European standards (EN). The measuring system is designed for use in industrial and laboratory applications.

The EU Declaration of Conformity and the technical documentation are available to the responsible authorities according to the EU Directives.

1.3.2 UKCA Marking

The following apply to the interferoMETER IMS5420:

- SI 2016 No. 1091:2016-11-16 The Electromagnetic Compatibility Regulations 2016
- SI 2012 No. 3032:2012-12-07 The Restriction of the Use of Certain Hazardous Substances in Electrical and Electronic Equipment Regulations 2012

Products which carry the UKCA mark satisfy the requirements of the directives cited and the relevant applicable standards. The sensor is designed for use in industrial environments.

The UKCA Declaration of Conformity and the technical documentation are available to the responsible authorities according to the UKCA Directives.

1.4 Intended Use

- The interferoMETER measuring system is designed for use in industrial environments and domestic areas. It is used for
 - thickness and surface inspection
 - monitoring quality and checking dimensions
- The measuring system must only be operated within the limits specified in the technical data, see [Chap. 3.6](#).
- The system/sensor/controller must be used in such a way that no persons are endangered or machines and other material goods are damaged in the event of malfunction or total failure of the controller.
- Take additional precautions for safety and damage prevention in case of safety-related applications.

1.5 Proper Environment

Modell		IMS5420-TH24	IMS5420MP-TH24	IMS5420IP67-TH24
Protection class	Sensor	IP67(with connected sensor cable only) Lenses are excluded from protection class. Contamination of the lenses causes impairment or failure of the function.		
	Controller	IP40		IP67
Temperature range	Storage	-20 ... +70 °C (-4 ... +158 °F)		
	Operation	Sensor: +10 ... +50 °C (+50 ... +122 °F), front side		Sensor: +10 ... +60 °C (+50 ... +140 °F), front side
		Controller: +10 ... +50 °C (+50 ... +122 °F)		
Humidity		5 - 95% (non-condensing)		
Ambient pressure		Atmospheric pressure		
EMC		According to EN 61000-6-3 / EN 61326-1 (Class B) and EN 61 000-6-2 / EN 61326-1		

2. Laser Class

The following apply to the interferoMETER IMS5420-TH24, IMS5420MP-TH24 and IMS5420IP67-TH24 measuring systems:

The measuring system works with a

- measuring laser of a wavelength of 1100 nm with a max. power of ≤ 0.75 mW.

The measuring system falls within laser class 1.

The accessible radiation is harmless under predictable conditions.

For class 1 laser devices, impairment of color vision and disturbances, e.g., from a glare effect, cannot be excluded.

An LED signalizes by illumination that laser radiation emits from the optical opening of the light source SLED, see [Chap. 5.5](#).

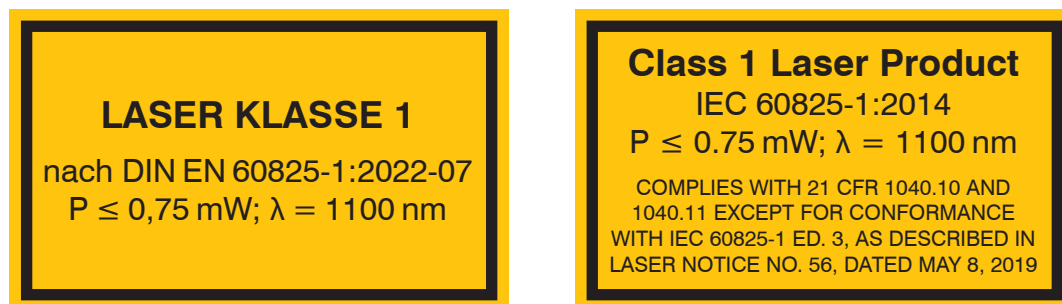

Fig. 1 Laser label measuring laser

The following apply to the interferoMETER IMS5420-TH24 and IMS5420MP-TH24 measuring systems:

The measuring system works with a

- pilot laser of a wavelength of 635 nm (visible red) offering max. power of ≤ 0.2 mW

The measuring system falls within laser class 1.

The accessible radiation is harmless under predictable conditions.

For class 1 laser devices, impairment of color vision and disturbances, e.g., from a glare effect, cannot be excluded.

An LED signalizes by illumination that laser radiation emits from the optical opening of the light source Pilot, see [Chap. 5.5](#).

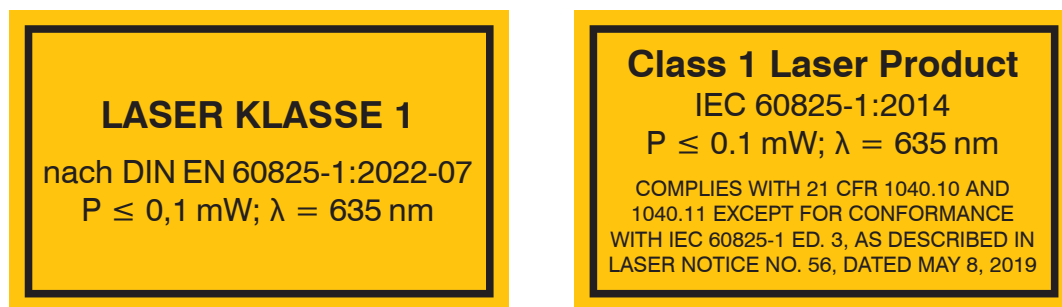

Fig. 2 Laser label pilot laser

3. Functional Principle, Technical Data

3.1 Short Description

The interferoMETER measuring system includes:

- IMP-THxx sensor
- IMC5420, IMC5420MP or IMC5420IP67 controller

The sensor is completely passive as it contains no heat sources or moving parts. This prevents any heat-related expansion, and ensures high precision of the measuring system.

The controller uses a spectrometer to convert any light signals that it receives from the sensor. It then calculates thickness using the integrated signal processor (CPU) and transfers the data via its interfaces or the analog output.

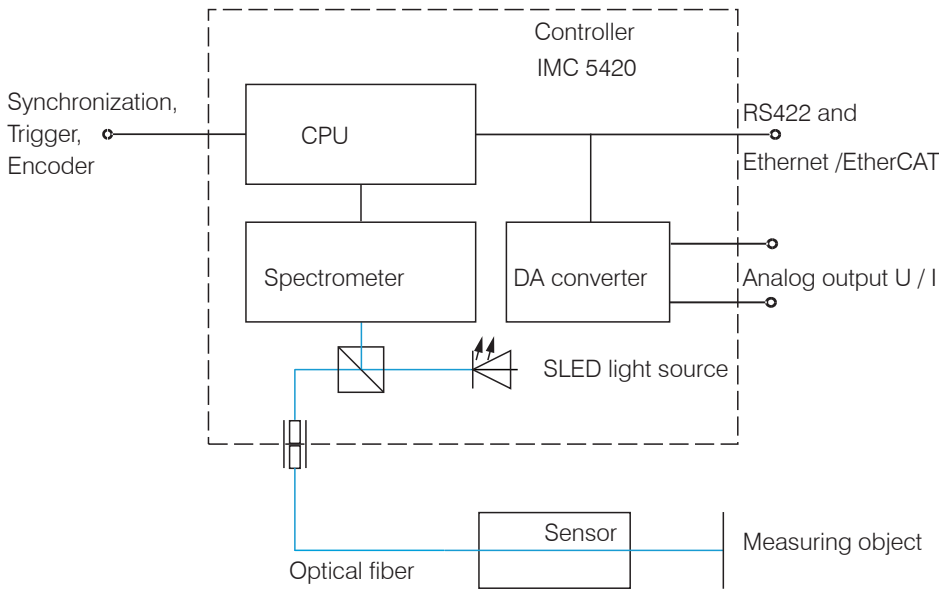

Fig. 3 Block diagram IMS5420-TH24

3.2 Measuring Principle

Polychromatic white light is generated by an SLED. The light is coupled into an optical fiber. The light radiates the measurement object. **The light reflected by the measuring object on the top and bottom of a layer is received by the sensor and conducted into the controller.**

The interferometric measuring principle (superposition of waves) is used. Detection of thicknesses is possible with amplification and elimination.

With a sensor for thickness measurement, no distance measurement is possible.

i Sensor and controller are one unit, as the sensor's linearization table is stored in the controller.

This unique measuring system allows for highly precise measurement of targets. It is possible to measure reflecting surfaces. For transparent layer materials, thickness measurements can be conducted. Shadowing is avoided because sender and receiver are aligned along one axis.

The excellent resolution and the small beam spot diameter make it possible to measure surface structures. However, measurement deviations may occur if the structure is of a similar size to the beam spot diameter or if the maximum tilt angle is exceeded (e.g., with groove edges).

3.3 Term Definitions

Working distance Optimal distance between sensor and target

Operating range Range where the target can move. Target is entirely in this range for a thickness measurement.

MR Thickness measuring range; maximum thickness is less than the operating range and depends on the refraction index/doping of the target material

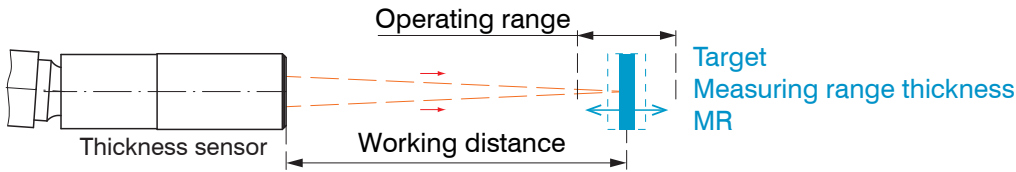

Fig. 4 Thickness sensor IMP-TH with working distance and operating range

3.4 Operating Modes

The interferoMETER measuring system provides highly accurate measurements of thicknesses for transparent layer materials.

The result of the measurement is a thickness value.

Operating range		6 mm
Measuring range (thickness)	Silicon	0.05 ... 1.05 mm ¹
	Air	0.2 ... 4 mm ²

Fig. 5 Measuring ranges for thickness measurements

The possible resolution here is in the nanometer range.

To get started quickly, it is recommended to use saved configurations (presets) for various target surfaces and applications, see [Chap. 6.6](#).

1) Measuring range with $n=3.82$ (silicon, undoped)

2) For air gap measurement between two glass plates ($n \sim 1$) the measuring range is 0.2 ... 4.0 mm. The measurement object must be within the working distance

3.5 Sensors

The controller can be operated with up to 8 different calibration tables.

The required calibration tables can be stored within the controller.

3.6 Technical Data IMS5420

Model		IMS5420-TH24	IMS5420MP-TH24	IMS5420IP67-TH24
Working distance		24 mm ±3 mm		
Measuring range (thickness)	Silicon	0.05 ... 1.05 mm ¹		
	Air	0.2 ... 4 mm ²		
Resolution ³		< 1 nm		
Measuring rate		continuously adjustable from 100 Hz to 6 kHz		
Linearity ⁴		< ±100 nm	< ±100 nm with one layer < ±200 nm for further layers	< ±100 nm
Temperature stability		temperature compensated, stability < ±50 ppm between +10 ... +50 °C		
Multi-layer measurement		1 layer	up to 5 layers	1 layer
Light source		SLED, wavelength 1100 nm, power < 0.75 mW pilot laser: wavelength 635 nm, power < 0.2 mW class 1 (IEC 60825-1: 2014)		SLED, wavelength 1100 nm class 1 (IEC 60825-1: 2014)
Light spot diameter ⁵		30 µm		
Measuring angle ⁶		±1,5°		
Supply voltage		24 VDC ±15 %, approx. 10 W (24 V)		
Signal input		sync in, trigger in, 2x encoders (A+, A-, B+, B-, index)		
Digital interface		Ethernet / RS422 / PROFINET ⁷ / EtherNet/IP ⁷		
		EtherCAT		---
Analog output		4 ... 20 mA / 0 ... 10 V (16 bit D/A converter)		---
Switching output		Error1-Out, Error2-Out		---
Digital output		Sync out		---
Connection	optical	pluggable optical fiber via E2000 socket (controller) and FC socket (sensor); standard length 3 m, 5 m and 10 m; other cable lengths on request; bending radius: static 30 mm, dynamic 40 mm		pluggable optical fiber via IP9 SC socket (Controller) and FC socket (sensor); standard length 1 m and 2 m; other cable lengths on request; bending radius: static 45 mm, dynamic 60 mm
	electrical	3-pin supply terminal strip; encoder connection (15-pin, HD-sub socket, max. cable length 3 m, 30 m with external encoder supply); RS422 connection socket (9-pin, Sub-D, max. cable length 30 m); 3-pin output terminal strip (max. cable length 30 m); 11-pin I/O terminal strip (max. cable length 30 m); RJ45 socket for Ethernet (out) / EtherCAT (in/out) (max. cable length 100 m)		4-pin M12 connector supply; 5-pin M12 connector RS422, max. cable length 30 m); 4-pin M12 RJ45 connector for Ethernet (out) / EtherCAT (in/out) (max. cable length 100 m)
Installation	Sensor	Clamping ø10 mm, mounting adapter (see accessories)		Clamping ø19.5 mm or thread M20 x 1.5
	Controller	free-standing, DIN rail mounting		through bores
Temperature range	Storage	-20 ... +70 °C (-4 ... +158 °F)		
	Operation	Sensor: +10 ... +50 °C (+50 ... +122 °F), front side		Sensor: +10 ... +60 °C (+50 ... +140 °F), front side
Shock (DIN-EN 60068-2-29)		15 g / 6 ms in XY axis, 1000 shocks each		
Vibration (DIN-EN 60068-2-6)		2 g / 20 ... 500 Hz in XY axis, 10 cycles each		
Protection class (DIN-EN60529)	Sensor	IP67, front side		IP67, front side
	Controller	IP40		IP67
Material	Sensor	Stainless steel		Stainless steel
	Controller	aluminum housing, passive cooling		Stainless steel
Control and display elements		multifunction button: two adjustable functions and reset to factory setting after 10 s;		---
		web interface for setup: selectable presets, freely selectable averaging possibilities, data reduction, setup management;		
		6 x color LEDs for intensity, range, SLED, pilot laser, status and power;		Power LED
		pilot laser: switchable for sensor alignment		---

All data at constant ambient temperature (22 ± 3 °C)

- 1) Measuring range with $n=3.82$ (silicon); measurable thickness depends on doping, see table below.
- 2) For air gap measurement between two glass plates ($n \sim 1$) the measuring range is 0.2 ... 4.0 mm. The measurement object must be within the working distance.
- 3) Measuring rate 0.5 kHz, moving averaging over 64 values, measured on an approx. 0.8 mm thick silicon polished on both sides (2 sigma)
- 4) Maximum thickness deviation when measuring on an approx. 0.8 mm thick silicon polished on both sides ($n=3.8$) when passing through the operating range
- 5) With a working distance of 24 mm (IMS5420, IMS5420MP) or 17.5 mm (IMS5420IP67)
- 6) Maximum sensor tilt angle that produces a usable signal on an approx. 0.8 mm thick silicon in the mid of the measuring range. The accuracy decreases when approaching the limit values.
- 7) Optional connection via interface module (see accessories)

Si-Wafer with doping	Minimum thickness	Maximum thickness
5.1 mOhmcm	50 μm	740 μm
6.4 mOhmcm	50 μm	830 μm
7.1 mOhmcm	50 μm	920 μm
9.1 mOhmcm	50 μm	>1100 μm

4. Delivery

4.1 Unpacking/Included in Delivery

1 Controller	IMS5420-TH24, IMS5420MP-TH24 or IMS5420IP67-TH24
1 Sensor	IMP-THxx
1 Accessory IMS5x00	(terminal blocks, Ethernet cables, etc.)
1 Acceptance report	
1 Quick manual	

- ▶ Carefully remove the components of the measuring system from the packaging and ensure that the goods are forwarded in such a way that no damage can occur.
- ▶ Check the delivery for completeness and shipping damage immediately after unpacking.
- ▶ If there is damage or parts are missing, immediately contact the manufacturer or supplier.

4.2 Storage

Temperature range storage:	-20 ... +70 °C (-4 ... +158 °F)
Humidity:	5 - 95 % (non-condensing)

5. Installation

5.1 IMC5420 and IMC5420MP Controller

Place the IMC5420 controller on a level surface or install it, e.g., in a control cabinet using a mounting rail (top-hat rail TS35) according to DIN EN 60715 (DIN rail).

When mounting the controller onto a DIN rail, an electrical connection (potential equalization) is established between the controller housing and the mounting rail.

▶ To remove the controller, push it upwards and pull it forwards.

i Position the controller so that the connections, controls and displays are not concealed.

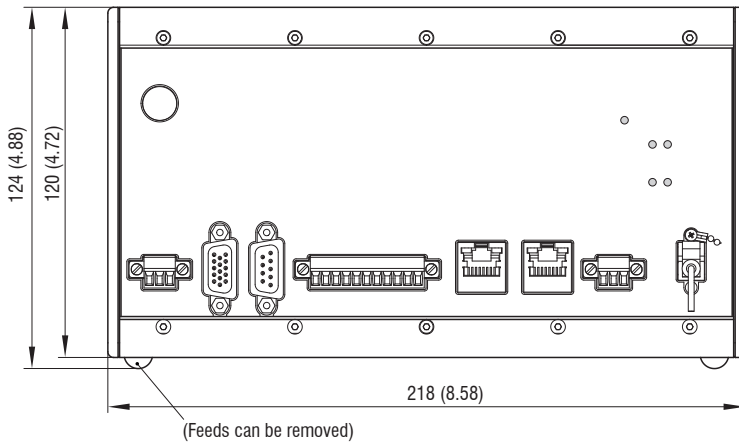

Fig. 6 Dimensional drawing, front view of IMC5420 controller, dimensions in mm (inches)

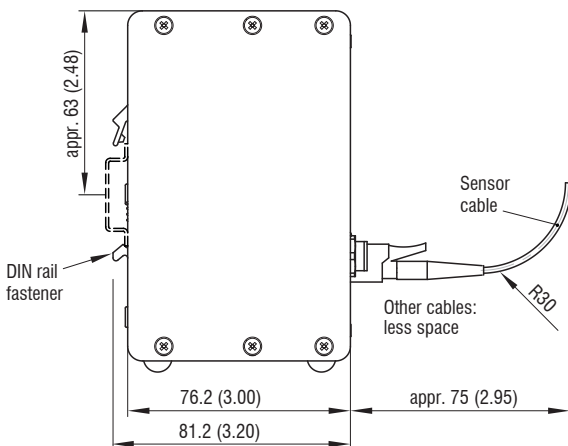

Fig. 7 Dimensional drawing, side view of IMC5420 controller, dimensions in mm (inches)

5.2 IMC5420IP67-TH24 Controller

Place the IMC5420IP67-TH24 controller on a level surface or install it using two M6 screws.

- i Position the controller so that the connections and LED are not concealed.

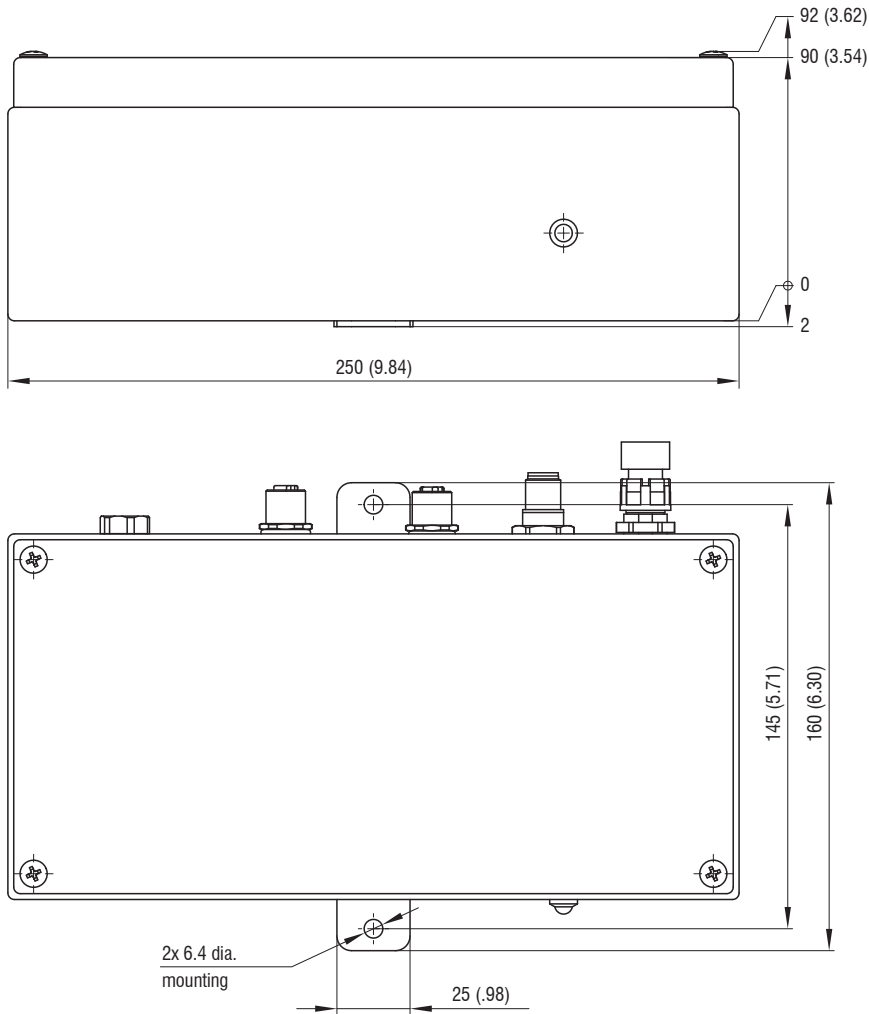

Fig. 8 Dimensional drawing, front and top view of IMC5420 controller, dimensions in mm (inches)

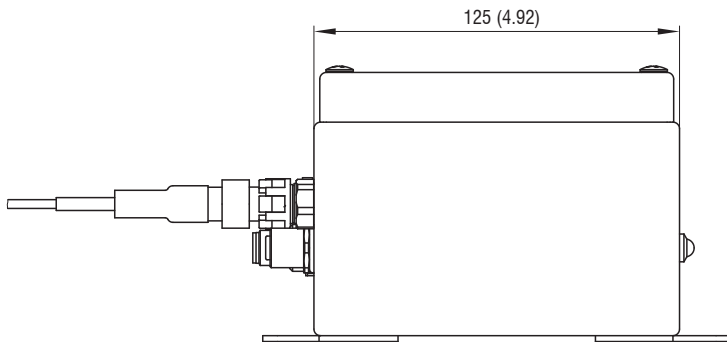

Fig. 9 Dimensional drawing, side view of IMC5420 controller, dimensions in mm (inches)

5.3 IMC5420 and IMC5420MP Controller Operating Elements

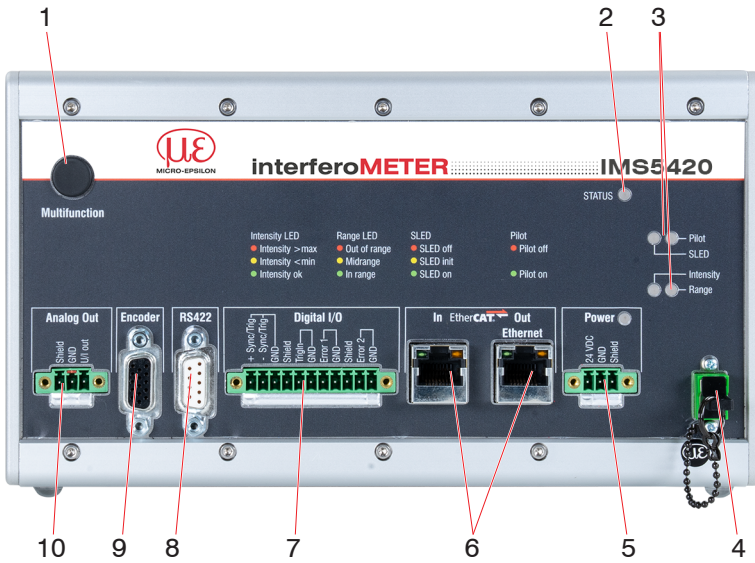

Fig. 10 Front view of IMC5420 and IMC5420MP controller

1	Multifunction button (light source) ¹	6	Ethernet/EtherCAT
2	LED Status	7	Digital I/O
3	LEDs intensity, range, pilot laser, SLED	8	RS422 connection
4	Sensor connection channel 1 (optical fiber)	9	Encoder connection
5	Power supply connection, LED Power On	10	Analog output (U / I)

1) Resetting to factory settings: press the Multifunction button for more than 10 sec.

5.4 IMC5420IP67-TH24 Controller Operating Elements

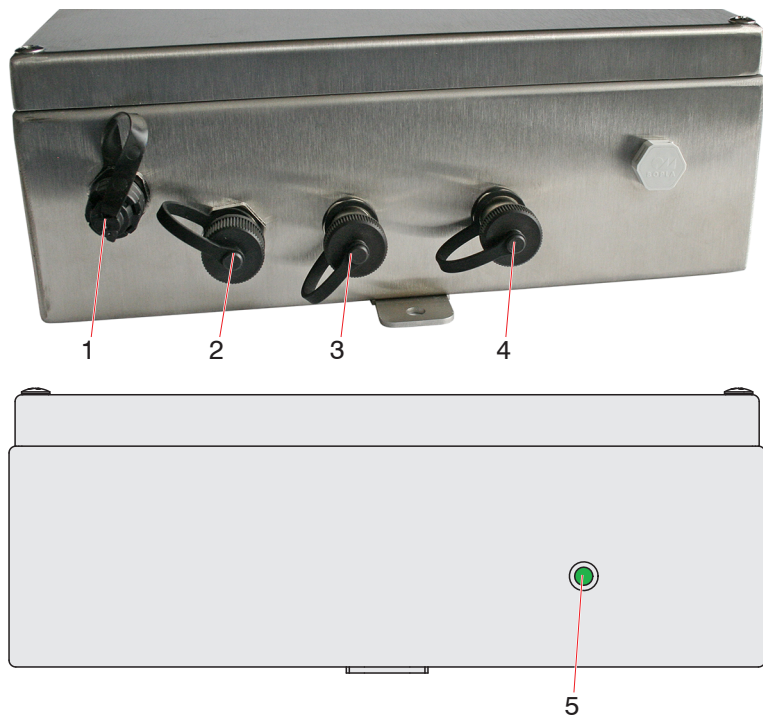

Fig. 11 Front view of IMC5420IP67 controller

1	Sensor connection channel 1 (optical fiber)	4	RS422 connection
2	Power supply	5	LED Power On
3	Ethernet		

5.5 LEDs IMC5420 and IMC5420MP Controller

Power on	Green	Operating voltage available
Status	Off	No error
	If EtherCAT is active, meaning of the LED is conform with the EtherCAT guidelines.	
Intensity 		
	Red	Signal in saturation
	Yellow	Signal too low
	Green	Signal ok
SLED 	Red	SLED off
	Red flashing	Error, SLED ist switched off
	Yellow	SLED warms up
	Green	SLED ready for operation
	Yellow flashing	SLED current outside the optimal value range ¹
Pilot 	Red	Pilot laser off
	Green	Pilot laser on
	Red	No target object, or target object outside the operating range. The expected number of peaks was not found or it was not possible to assign a thickness.
	Yellow	Target close to mid of operating range
	Green	Target within operating range The expected number of peaks was found. A valid thickness could be found for each peak.

Fig. 12 Meaning of the controller LEDs Status, Intensity, SLED, Pilot and Range

1) When measuring outside the optimum current value of the SLED, the controller will measure, but the measurement accuracy may not be as specified.

The LED's Intensity and Range flashes with their current color during a synchronization error.

5.6 LED IMC5420IP67 Controller

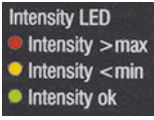
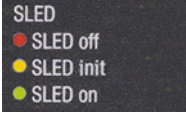
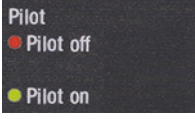
Power on	Green	Operating voltage available
----------	-------	-----------------------------

5.7 Electrical Connections IMC5420 and IMC5420MP Controller

5.7.1 Connection Possibilities

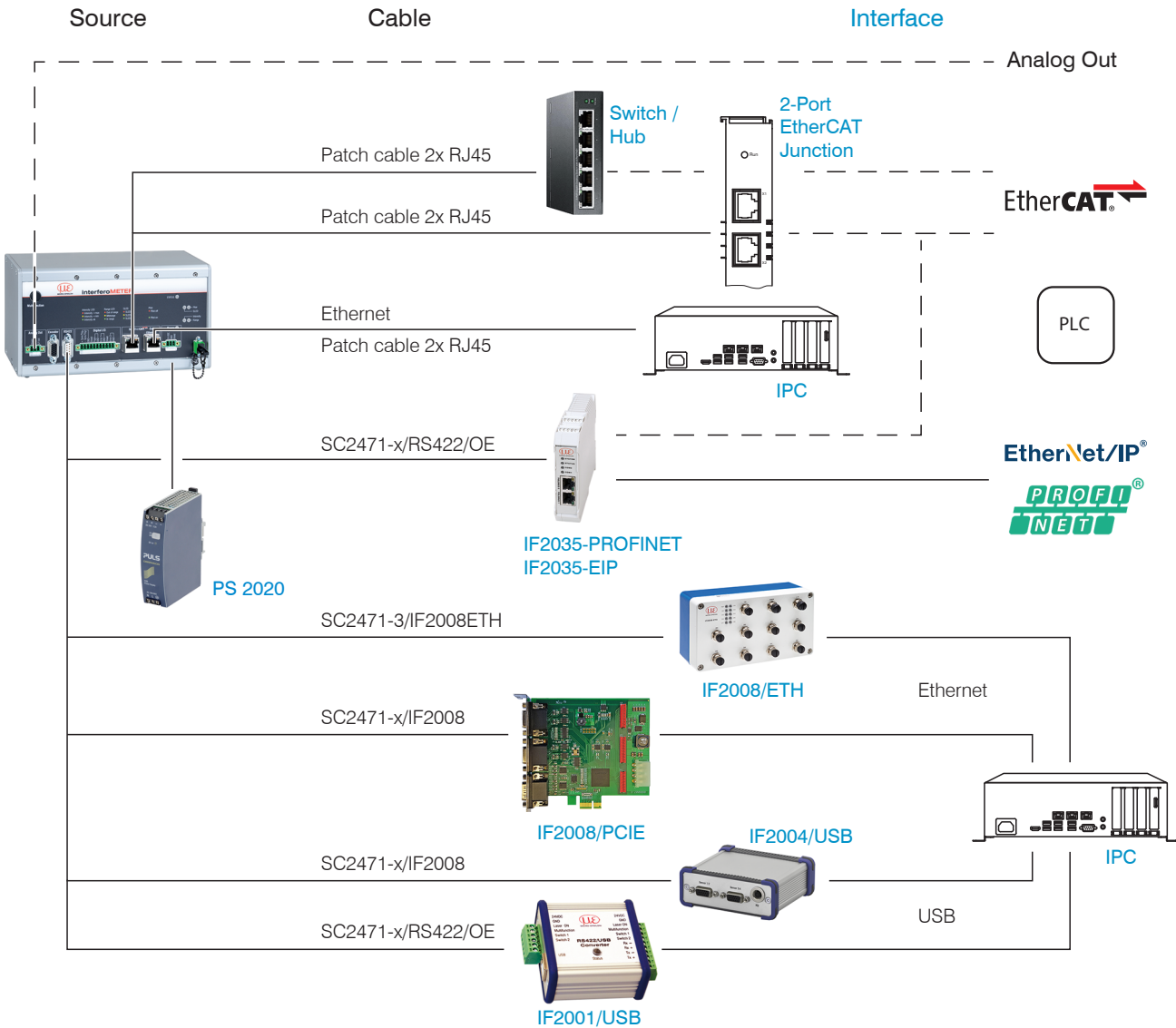

Fig. 13 Connection examples on IMS5420

5.7.2 Handling of Pluggable Screw Terminals

The IMC5x00 controller has three pluggable screw terminals for supply, digital I/O and analog out, which are included as accessories.

- ▶ Remove approx. 7 mm of the connecting wire insulation (0.14 ... 1.5 mm²).
- ▶ Connect the connecting wires.

ⓘ Use two captive screws to fix the screw terminals.

5.7.3 Grounding, Shielding

All inputs/outputs are electrically connected to the supply voltage ground (GND). Only the Ethernet/EtherCAT ports are electrically isolated.

The ground connections (GND, GND422, GND_ENC) of each connection group are galvanically interconnected via chokes.

The Shield connections of each connection group are only connected with the controller housing and are used for cable screen connections with individual connections (power, analog output, switching outputs, synchronization and trigger input).

Only use screened cables shorter than 30 m and connect the cable screen to the Shield or the connector housing.

5.7.4 Supply Voltage (Power)

CAUTION Observe the safety instructions when handling supply voltage. Injury possible.

- 3-pin pluggable screw terminal (24 VDC, GND, Shield),
- 24 VDC \pm 15 %, $I_{max} < 1$ A
- not electrically separated, GND is electrically connected to GND for switching outputs, synchronization and encoder input.

➔ Use shielded cable with a length < 30 m.

Voltage supply only for measuring devices, not to be used for drives or similar sources of impulse interference at the same time. MICRO-EPSILON recommends using an optional available power supply unit PS2020 for the controller.

After the supply voltage has been switched on, the `Power` LED lights up.

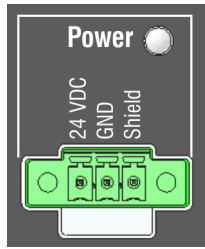

Fig. 14 Supply connections and LED on the IMC5x00 controller

5.7.5 RS422

- Differential signals in accordance with EIA-422, electrically isolated from the supply voltage.
- Receiver Rx with a 120 ohm internal terminating resistor.

➔ Terminate the transmitter input (TX) with 90 ...120 ohm on the evaluation unit (receiver).

➔ Use a shielded twisted cable. Cable length less than 30 m.

➔ Connect the ground connections.

i The pin assignment for the 9-pin D-sub socket is not standardized.

Pin	Color SC2471-x/RS422/OE	Name	Signal	
3	green	RX -	Receiver -	
2	brown	RX +	Receiver +	
5	yellow	GND422	RS422 ground	
9	grey	TX +	Transmitter +	
1	white	TX -	Transmitter -	
Housing	Shield		Cable shield	

Fig. 15 Pin assignment for the 9-pin D-sub connector (RS422)

5.7.6 Ethernet, EtherCAT

Potential-separated RJ 45 standard socket for connecting the IMC5x00 controller

- to an Ethernet network (PC) or
- the EtherCAT bus system (IN-Port).

➔ Use a shielded Ethernet cable (Cat5E, patch cable, 2 m, included in the delivery), overall cable length less than 100 m to connect controller and network.

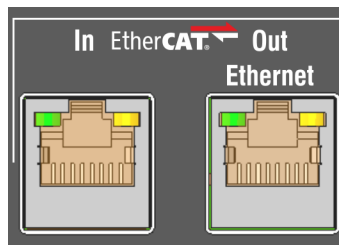

Fig. 16 Connectors RJ45 for Ethernet, EtherCAT

Both LEDs in each of the plug-in connectors indicate a successful connection and its activity.

The controller can be configured using

- the web interface, see [Chap. 6](#), see [Chap. 7](#),
- ASCII commands, see [Chap. A 3](#) or
- EtherCAT, see [Chap. A 4](#).

5.7.7 Analog Output

The analog output can be used via the 3-pin screw terminal and is electrically connected to the supply voltage. For the output, you can select current or voltage, see [Chap. 7.5.4](#).

Voltage: Pin U/I_{out} and Pin GND,

R_i approx. 50 Ohm, $R_L > 10$ MOhm

Slew rate (no C_L , $R_L \geq 1$ kOhm) typ. 0.5 V/ μ s

Slew rate (with $C_L = 10$ nF, $R_L \geq 1$ kOhm) typ. 0.4 V/ μ s

Current: Pin U/I_{out} and Pin GND

$R_L \leq 500$ Ohm

Slew rate (no C_L , $R_L = 500$ Ohm) typ. 1.6 mA/ μ s

Slew rate (with $C_L = 10$ nF, $R_L = 500$ Ohm) typ. 0.6 mA/ μ s

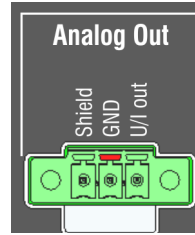

Fig. 17 Analog outputs on the controller

▶ Use a shielded cable. Cable length less than 30 m.

Pin 3 (Shield) is connected to the cover.

Alternatively, the following values may be defined for the output range:

Voltage: 0 ... 5 V; 0 ... 10 V;

Current: 4 ... 20 mA.

i The socket is mechanically coded (red plug-in) in order to avoid any confusion with the power supply.

5.7.8 Switching Outputs (Digital I/O)

The two switching outputs **Error 1/2** on the 11-pin pluggable screw terminal are electrically connected to the supply voltage.

The switching behavior (NPN, PNP, Push-Pull) is programmable, I_{max} 100 mA.

The maximum auxiliary voltage for a switching output with NPN switching behavior is 30 V.

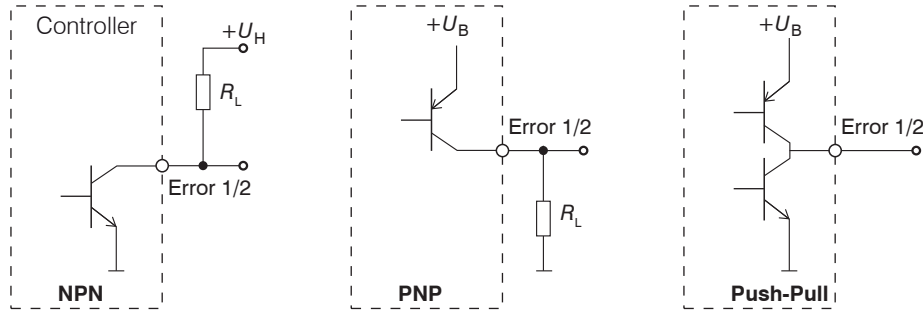

Fig. 18 Output behavior and switching output circuit Error 1/2

Switching output 1: pin Error 1 and GND

Switching output 2: pin Error 2 and GND

Cable shield: Shield is connected to the cover. Connect the cable shield.

All GND conductors are interconnected with one another and to operating voltage ground.

➤ Use a shielded cable. Cable length less than 30 m.

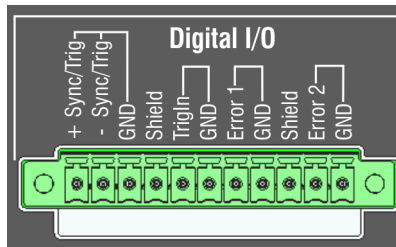

Fig. 19 Digital I/O on the controller

Output level (no load resistance), with a supply voltage of 24 VDC	Low < 1 V; High > 23 V
Saturation voltage at I_{max} 100 mA	Low < 2.5 V (Output - GND)
	High < 2.5 V (Output - + U_B)

The saturation voltage is measured between output and GND (output = Low), or between output and U_B (output = High).

Designation	Output active (error)	Output passive (no error)
NPN (Low side)	GND	+ U_H
PNP (High side)	+ U_B	GND
Push-Pull	+ U_B	GND
Push-Pull, negated	GND	+ U_B

Fig. 20 Switching behavior of the error outputs

NOTICE

The load resistance R_L can be dimensioned according to the limit values (I_{max} 100 mA, U_{Hmax} = 30 V) and requirements.

Do not connect inductive loads, e.g., a relay, without a parallel protective diode.

5.7.9 Synchronization (Inputs/Outputs)

For the pin assignment of the 11-pin pluggable screw terminal, see Fig.

- +Sync/Trig and -Sync/Trig pins: symmetrical synchronization output/input or trigger input, function and (I/O) direction are programmable.
- The terminating resistor R_T (120 Ohm) can be switched on and off, see [Chap. 7.1.5](#).

All GND conductors are interconnected with one another and to operating voltage ground.

Signal	Level	
Sync/Trig	RS422 (EIA422)	
The function and direction are programmable		

Fig. 21 Signal level synchronization, triggering

- ▶ Activate the terminating resistor (120 Ohm) in the last controller (slave n) in the chain.

Star synchronization

- ▶ Connect the pins +Sync/Trig and -Sync/Trig of controller 1 (master) in star configuration with the pins +Sync/Trig and -Sync/Trig of controller 2 (slave) to controller n, in order to synchronize two or more controllers.
- Partial cable length less than 30 m with star synchronization.

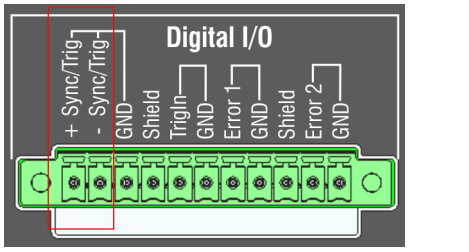
Cascaded synchronization

- ▶ Connect the pins +Sync/Trig and -Sync/Trig of controller 1 (master) with the pins +Sync/Trig and -Sync/Trig of controller 2 (slave 1). Connect the pins of downstream controllers in order to synchronize two or more controllers.
- Total cable length less than 30 m with cascaded synchronization.

- ▶ Use a shielded twisted cable.
- ▶ Connect the cable shield to Shield.
- ▶ Set Controller 1 to Master and the other controllers to Slave, see [Chap. 7.1.1](#).

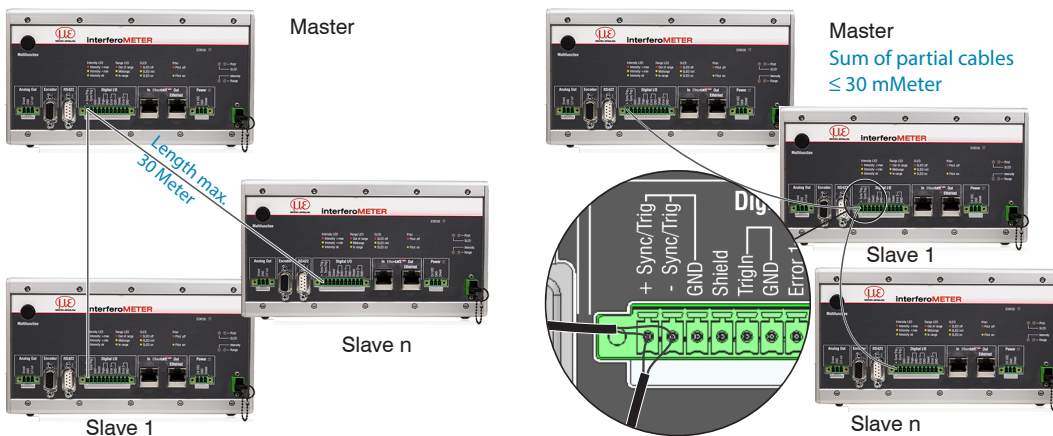

Fig. 22 Synchronization of more controllers, star synchronization (left), cascaded (right)

- ▶ Interconnect all GND, if the controllers are not supplied from a common power supply.
- ⓘ If the controllers are operated using EtherCAT, synchronization is performed using this connection.

5.7.10 Triggering

The pluggable 11-pin screw terminal with Digital I/O has two trigger inputs.

Sync/Trig input

The Sync/Trig port can be used as symmetrical trigger input.

Configure the Sync/Trig ports of the controllers as trigger inputs.

The trigger source must provide a symmetrical output signal according to the RS422 standard.

For asymmetrical trigger sources, we recommend inserting the SU4 level converter (3 channels TTL/HTL to RS422) between trigger source and controller.

Encoders are not suitable for trigger purposes.

TrigIn input

The TrigIn switching input is equipped with an internal pull-up resistor of 15 kOhm. An open input is identified as High.

Trigger sources can be switching contacts, transistors (NPN, N-channel FET) and SPS outputs.

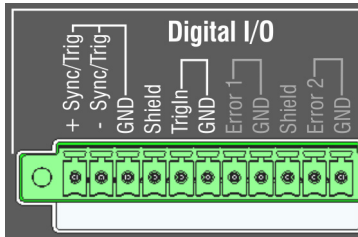

Electrical properties

- Programmable logic (TTL/HTL),
- TTL: Low level ≤ 0.8 V; High level ≥ 2 V
- HTL: Low level ≤ 3 V; High level ≥ 8 V (max. 30 V),
- Minimum pulse width 50 μ s

5.7.11 Encoder Inputs

Two encoders ¹ can be connected simultaneously to the 15-pin HD-Sub socket and supplied via 5 V.

Each encoder provides the signals A, B and N (zero impulse, reference, index) The maximum pulse frequency is 1MHz.

RS422 level (symmetrical) for A, B, N

Encoder supply 5 V: each 5 V, max. 300 mA

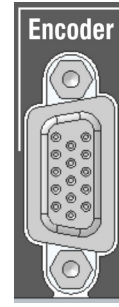

15-pin HD socket

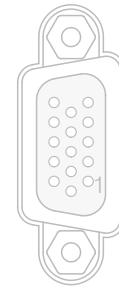

View on solder pin side male cable connector

Encoder	Pin	Signal	Encoder	Pin	Signal
1	1	GND ENC1	2	11	GND ENC2
	5	A1+		3	A2+
	4	A1-		2	A2-
	10	N1+ / A3+ ¹		8	N2+ / B3+ ¹
	9	N1- / A3- ¹		7	N2- / B3- ¹
	15	B1+		13	B2+
	14	B1-		12	B2-
	6	ENC U _p +5V		6	ENC U _p +5V
Connector housing		Controller housing		Cable shield	

Fig. 23 Pin assignment encoder inputs

▶ Use a shielded cable. Cable length less than 3 m. Connect the cable shield to the housing.

Connection requirements

The encoders must provide symmetrical RS422 signals.

If the encoder has no RS422 outputs, we recommend a level converter SU4 (3 channels TTL/HTL to RS422) between trigger signal source and controller.

The two encoders can be supplied with the controller voltage ENC U_p +5V and loaded with a maximum of 300 mA. If you use supply voltage, the cable to the encoder must not be longer than 3 meters.

The inputs are not electrically isolated from supply voltage.

1) If the encoders are operated without reference tracks (N), the reference tracks (N) can be used as a third encoder.

5.8 Electrical Connections IMC5420IP67-TH24 Controller

5.8.1 Connection Possibilities

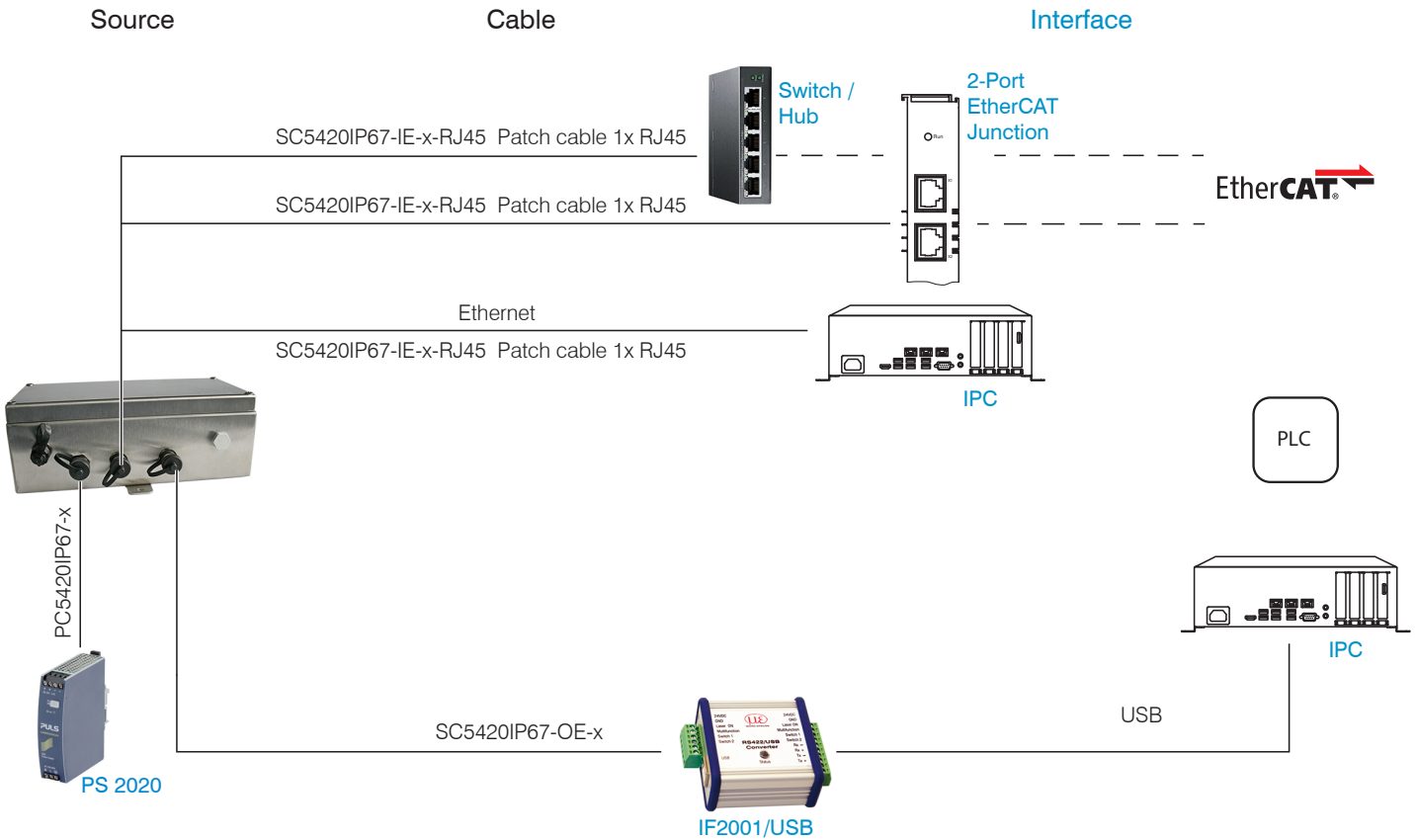

Fig. 24 Connection examples on IMC5420IP67-TH24

5.8.2 Grounding, Shielding

All inputs/outputs are electrically connected to the supply voltage ground (GND). Only the Ethernet/EtherCAT ports are electrically isolated.

The ground connections (GND and GND422) of each connection group are galvanically interconnected via chokes.

The Shield connections of each connection group are only connected with the controller housing and are used for cable screen connections with individual connections (power, analog output, switching outputs, synchronization and trigger input).

Only use screened cables shorter than 30 m and connect the cable screen to the Shield or the connector housing.

5.8.3 Supply Voltage (Power)

CAUTION Observe the safety instructions when handling supply voltage. Injury possible.

- 4-pin M12 socket (24 VDC, GND, Shield),
 - 24 VDC \pm 15 %, $I_{max} < 1$ A
 - not electrically separated, GND is electrically connected to GND for switching outputs, synchronization and encoder input.
- ➔ Use shielded cable with a length < 30 m.

Voltage supply only for measuring devices, not to be used for drives or similar sources of impulse interference at the same time. MICRO-EPSILON recommends using an optional available power supply unit PS2020 for the controller.

Pin	Color PC5420-x	Signal
1	brown	+ U_B
3	blue	GND



Fig. 25 Male connector on the IMC5420IP67-TH24 controller

Fig. 26 Pin assignment for the 4-pin male M12 connector (Power)

After the supply voltage has been switched on, the `Power` LED lights up.

5.8.4 RS422

- Differential signals in accordance with EIA-422, electrically isolated from the supply voltage.
- Receiver Rx with a 120 ohm internal terminating resistor.

- ➔ Terminate the transmitter input (TX) with 90 ... 120 ohm on the evaluation unit (receiver).
- ➔ Use a shielded twisted cable. Cable length less than 30 m.
- ➔ Connect the ground connections.

i The pin assignment for the 5-pin M12 socket is not standardized.

Pin	Color SC5420IP67-OE-x	Name	Signal
1	yellow	RX -	Receiver -
2	green	RX +	Receiver +
3	grey	GND422	RS422 ground
4	pink	TX +	Transmitter +
5	brown	TX -	Transmitter -
Housing	Shield		Cable shield



Fig. 27 Pin assignment for the 5-pin female M12 connector (RS422)

5.8.5 Ethernet

Potential-separated M12 socket with D coding for connecting the IMC5420IP67-TH24 controller.

- to an Ethernet network (PC) or
 - the EtherCAT bus system (IN-Port).
- ➔ Use a shielded SC5420IP67-IE-x-RJ45 Ethernet cable, overall cable length less than 100 m, to connect controller and network.



Fig. 28 Female connector for Ethernet

The controller can be configured using

- the web interface, see [Chap. 6](#), see [Chap. 7](#),
- ASCII commands, see [Chap. A 3](#)

5.9 Sensor Cable

Sensor and controller are connected through an optical fiber.

- Do not shorten or extend the optical fiber.
- Do not pull or hold the sensor on the optical fiber.
- The optical fibers has a diameter of 50 μm .

Contamination of the plug-in connector should be avoided; otherwise, there may be particle deposits and a strong loss of light. Cleaning of the connectors requires the corresponding know-how and a fiber microscope for control.

NOTICE

As a matter of principle, avoid:
 any contamination of the connector, e.g., dust or finger prints,
 unnecessary mating cycles,
 any mechanical stress of the optical fiber (bending, crushing, pulling, twisting, knotting etc.),
 tight curvature of the optical fiber because the glass fiber is damaged in the process and this causes permanent damage.

Never bend the cable more tightly than the permissible bending radius.



Fixed:
 $R = 30 \text{ mm}$ or more

Flexible:
 $R = 40 \text{ mm}$ or more

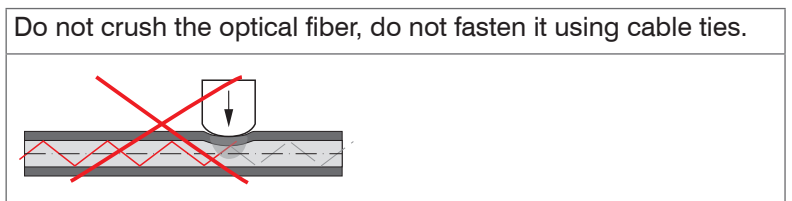
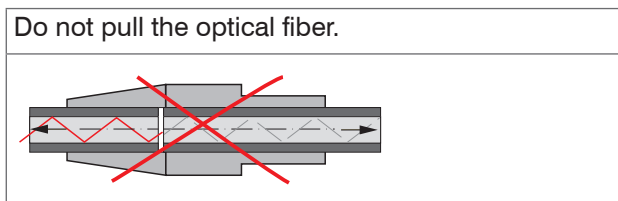
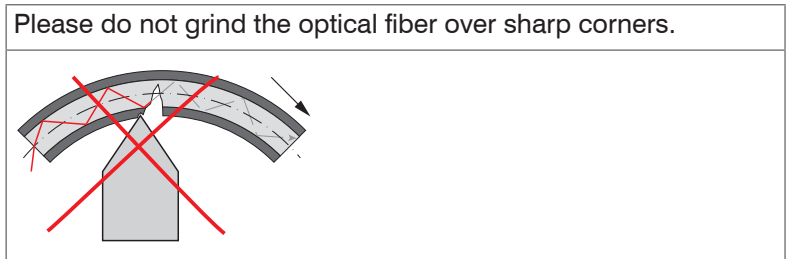
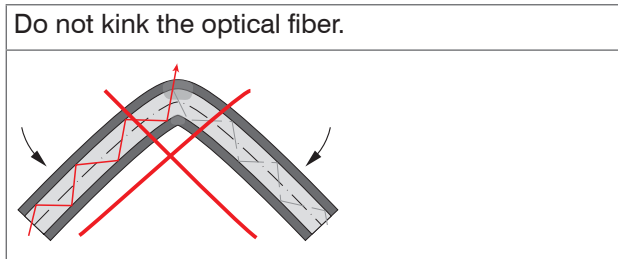

IMP-DS, IMP-TH (standard sensors)

The optical fiber on the sensor is plugged in. Optionally, lengths up to 50 m, optical fibers for use with drag cables or optical fibers with protective metal tubing are available.

Connecting the optical fiber to the IMC5420 controller

- Remove the dummy connector from the green optical fiber socket on the controller.
- Plug the sensor cable (green connector, E2000/APC) into the socket, and ensure that the connector is aligned correctly.
- Push the connector into the socket until it locks.



Sensor 1

Fig. 29 Connection of sensor cable to the controller

Removing the optical fiber from the controller

- Press down the connector's release lever and unplug the connector from the socket.
- Plug again the dummy connector.

NOTICE

Close the optical inputs and outputs with dummy plugs when no optical fiber is connected.

Connecting the optical fiber to the IMC5420IP67-TH24 controller

- Remove the dummy connector from the black optical fiber socket on the controller.
- Plug the sensor cable (green marking) into the socket.

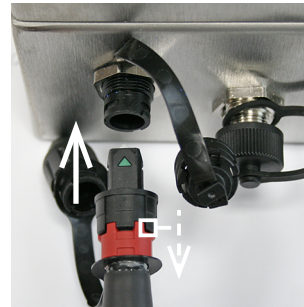

- Push the black locking device forward.
- Turn the black locking device to the right until it audibly engages.



- Push the red fuse to the front.

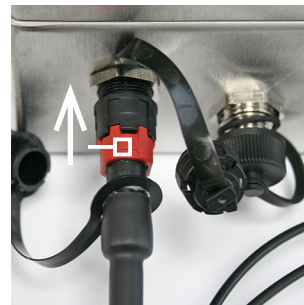

Fig. 30 Connection of sensor cable to the IMC5420IP67-TH24 controller

Removing the optical fiber from the controller

- Push the red lock to the rear and turn the black lock to the right.
- Unplug the connector from the socket.
- Plug again the dummy connectors to the socket and the sensor cable.

5.10 Sensors

5.10.1 Sensor Dimensions

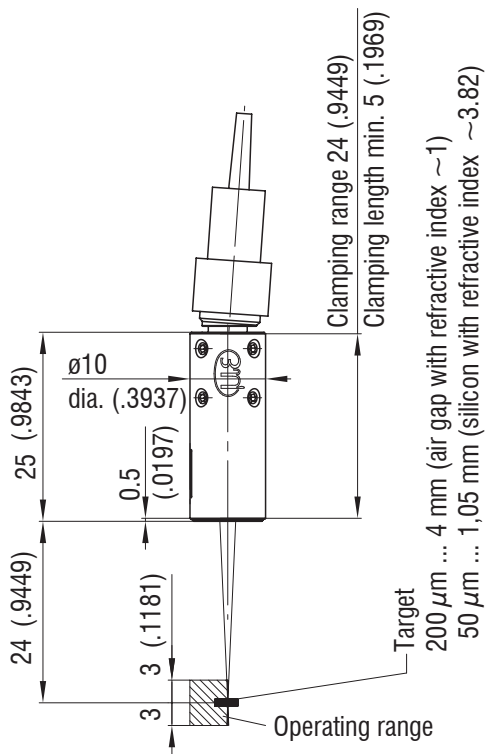

Fig. 31 IMP-TH24 thickness sensor

↑ ↑ ↑ Measurement direction

Dimension in mm (Inch)

5.10.2 Start of Measuring Range

A working distance must be maintained for each sensor.

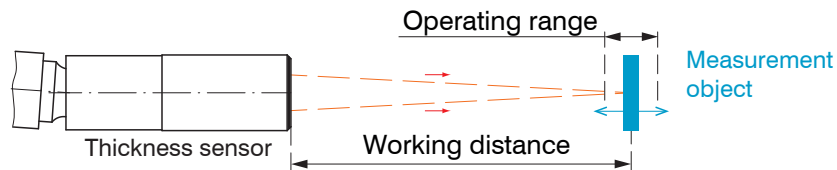

The operating range is symmetrical located to the working distance.

The exact value for the working distance can be found in the acceptance report.

5.10.3 Mounting, Mounting Adapter

The IMP series sensors use an optical measuring principle that allows for measurements in the nm range.

- Ensure careful handling during installation and operation.

Mount the sensors with an outer clamp. This type of sensor installation ensures the highest level of reliability because the sensor's cylindrical cover is clamped over a relatively large area. It must be used in complex installation environments, such as machines, production systems etc.

▶ Use an installation bracket MA5400-10 to mount IMP-TH24 sensors.

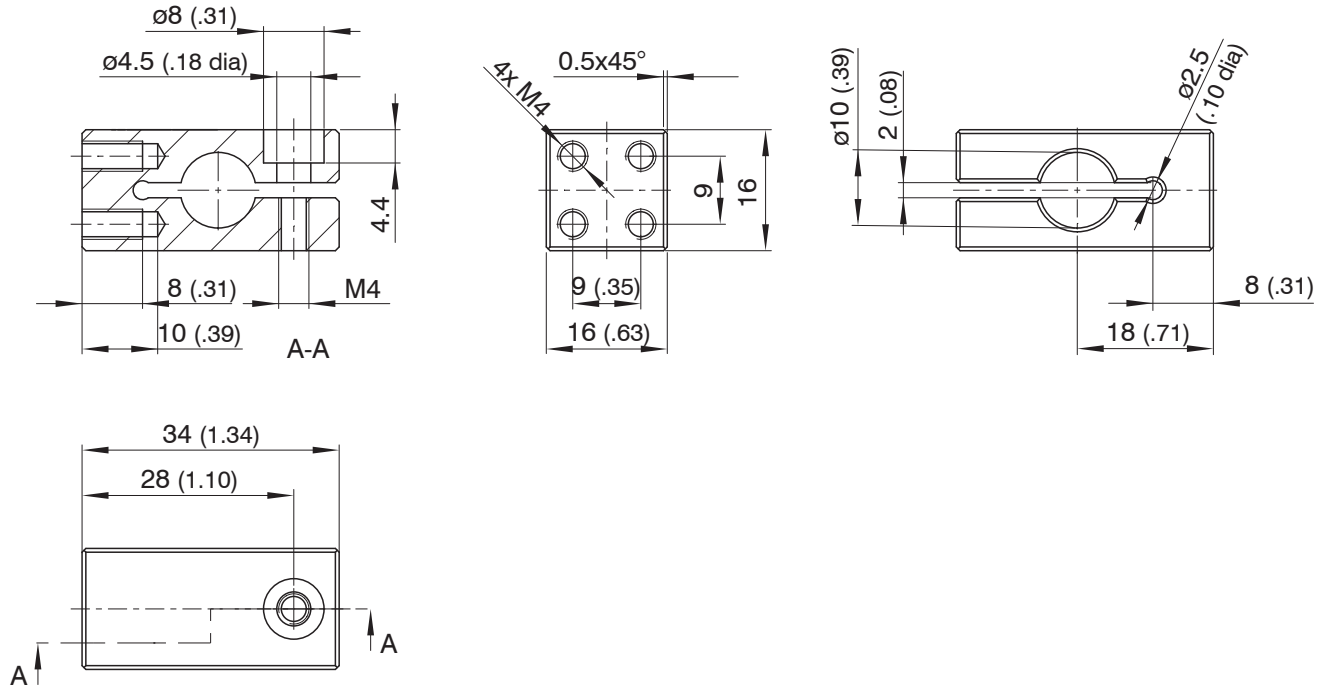

Fig. 32 MA5400-10 installation bracket

6. Operation

6.1 Initial Operation

- Connect the controller to a power supply, see [Chap. 5](#).
- Connect the sensor and the controller using the optical fiber, see [Chap. 5.9](#).

Initializing starts after the voltage supply has been switched on. The measuring system is ready for use after approx. 10 seconds. To ensure precise measurements, let the measuring system warm up for approx. 60 minutes. This can be configured using the web page integrated in the controller, ASCII commands, see [Chap. A 3](#) or EtherCat, see [Chap. A 4](#).

6.2 Control via Ethernet

6.2.1 Requirements

The controller provides web pages for configuration. Operation is only possible while there is an Ethernet connection to the controller.

To support easy initial operation of the controller, it is set to a static IP address by default. The controller is factory set to the static IP address 169.254.168.150. Use this address for a direct connection with a browser. If you have configured your browser so that it accesses the Internet via a proxy server, please add the IP address of the controller in the browser settings to the list of addresses which should not be routed via the proxy server. The MAC address of the measuring instrument can be found on the rating plate of the controller and on the acceptance report.

- You require an HTML5-capable web browser. This applies from the following browser versions:

Google Chrome 25.0		Internet Explorer 11.0		Mozilla Firefox 19.0
--------------------	--	------------------------	--	----------------------



Direct connection to PC, controller with static IP (factory setting)		Network
PC with static IP	PC with DHCP	Controller with dynamic IP address, PC with DHCP
➤ Connect the controller to a PC using a direct Ethernet connection (LAN). To do so, use a LAN cable with RJ-45 connectors.		➤ Connect the controller to a switch using a direct Ethernet connection (LAN). To do so, use a LAN cable with RJ-45 connectors.
➤ Start the program sensorTOOL.exe. This program is available online at https://www.micro-epsilon.de/download/software/sensorTOOL.exe . ➤ Click the  button. Select the desired controller from the list. In order to change the address settings, click the <code>Configure Sensor IP</code> button. <ul style="list-style-type: none"> • Address type: static IP address • IP address: 169.254.168.150¹ • Subnet mask: 255.255.0.0 ➤ Click the <code>Open Website</code> button to connect the controller to your default browser. 1) This assumes that the LAN connection on the PC uses the following IP address, for example: 169.254.168.1.	Wait until Windows has established a network connection (connection with limited connectivity). ➤ Start the program sensorTOOL.exe. ➤ Click the  button. Now select the desired controller from the list. ➤ Click the <code>Open Website</code> button to connect the controller to your default browser.	➤ Enter the controller in the DHCP / register the controller with your IT department. Your DHCP server assigns an IP address to your controller. You can request this IP address by using sensorTOOL.exe. ➤ Start the program sensorTOOL.exe. ➤ Click the  button. Now select the desired controller from the list. ➤ Click the <code>Open Website</code> button to connect the controller to your default browser. OR: When using DHCP with the DHCP server coupled to the DNS server, access to the controller is possible using a host name with the structure "IMC5x00_SN<Serial number>". ➤ Start a web browser. To reach an IMC5x00 with serial number "01234567", type "IMC5x00_SN01234567" into the address bar of the browser.

Fig. 33 Options for connecting to a LAN

6.2.2 Access via Web Interface

Interactive web pages you can use to configure the controller are now displayed in the web browser. The controller is active and supplies measurement values.

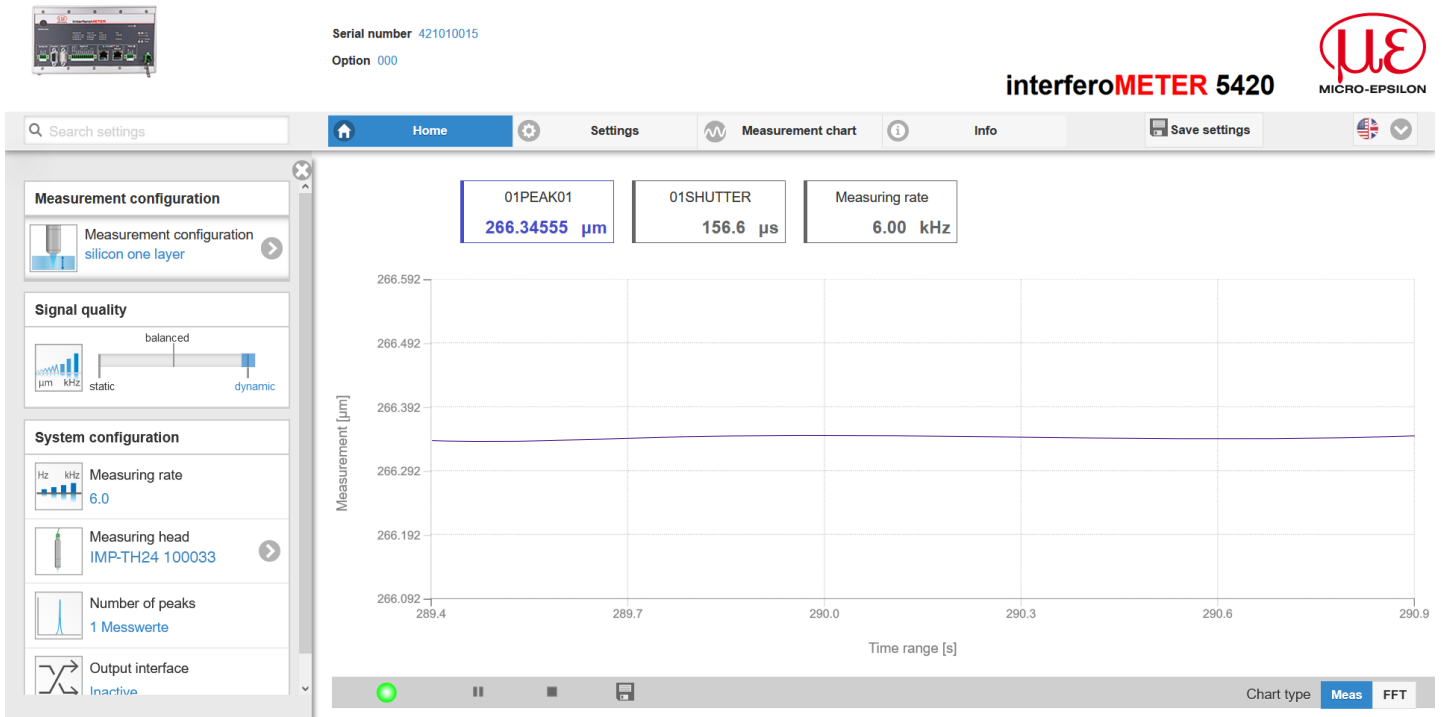

Fig. 34 First interactive web site after calling IP address

The horizontal navigation includes the functions below:

The search function permits time-saving access to functions and parameters.

Home. The web interface automatically starts in this view with measurement chart, Configuration and Signal quality.

Settings. This menu includes all sensor parameters, see [Chap. 7](#).

Measurement chart. Measurement chart with digital display or overlay of the video signal.

Info. Includes information about the sensor, such as measuring range, serial number and software status.

Web interface language selection

All settings are immediately copied and transmitted to the controller.

Parallel operation with web browser and ASCII commands is possible; the last setting applies.

The appearance of the websites can change dependent of the functions. Dynamic help text with excerpts from the operating instructions supports you during sensor configuration.

i Depending on the selected measuring rate and the PC used, measured values may be reduced dynamically in the display. That is, not all measured values are transmitted to the web interface for display and saving.

6.3 Select a Sensor

Controller and sensor(s) are matched at the factory.

➤ Go to the `Settings > Sensor` menu.

➤ Select a sensor from the list.

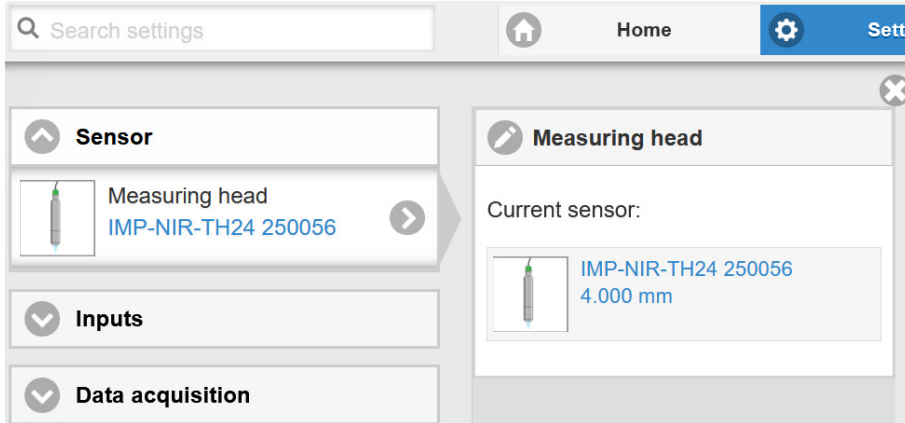

The calibration data of up to 20 different sensors can be stored in the controller. Calibration is done at factory only.

6.4 Button Multifunction

The Multifunction button of the controller has multiple functions. It enables, e.g., to operate the light source.

The button is factory-set to the `Pilotlaser on/off` feature. Modification of the assignment is possible in the `Settings > Inputs` menu. Modifying the assignment requires the `Professional` authorization.

	Key function 1 / 2	Set / reset master value	Starts or stops mastering of the selected signals
		Pilot laser	<i>Turns on/off the pilot laser</i>
		SLED	<i>Turns the light source on/off for the sensor</i>
		Inactive	<i>Key has no function</i>

There are two defined time intervals for pressing the button; each of these can be assigned a function. All time intervals are indicated by the LEDs flashing/lighting up.

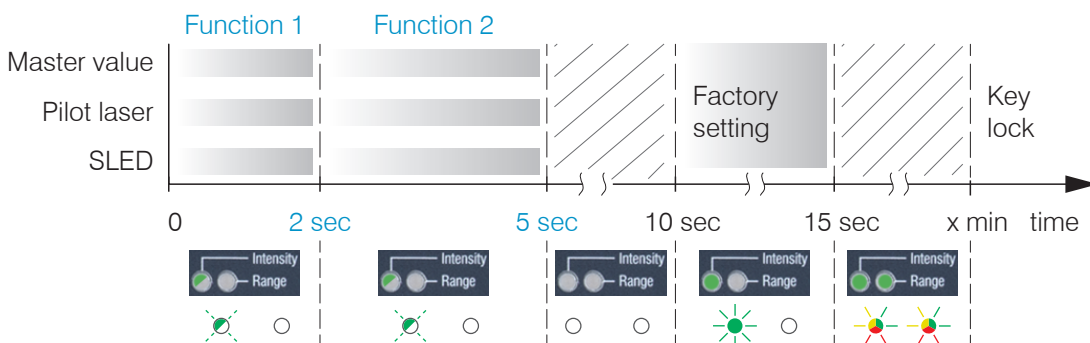



Fig. 35 Button press duration

 Grey shaded fields require a selection.

Value  Fields with dark border require entry of a value.

6.5 Positioning the Target, Thickness Measurement

The red-light pilot laser supports you in aligning the sensor to the target during commissioning.

Turn on or off the pilot laser in the menu `Settings > System settings`.

➡ Position the target (measurement object) as much as possible in the mid of the operating range.

The peak positions remains stable in the FFT signal, even though the measurement target moves. The peak position depends on the target thickness.

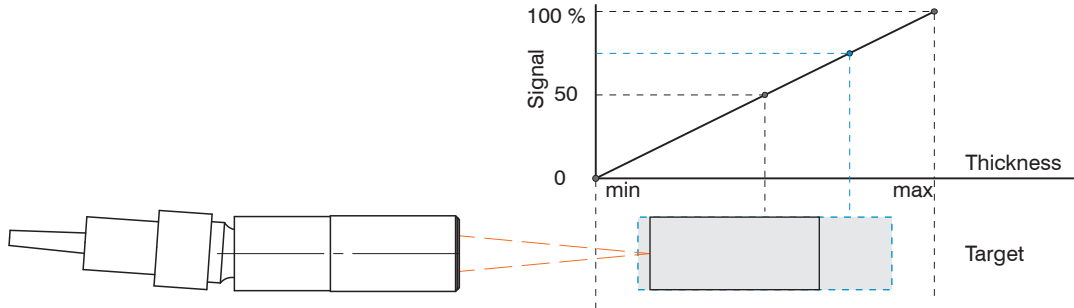

Fig. 36 Basics thickness measurement

The LED Range on the controller front indicates the position of the target in relation to the sensor.

Range LED ● Out of range ● Midrange ● In range	Red	No target or target outside the measuring range
	Yellow	Target close to mid of measuring range
	Green	Target within measuring range
Pilot ● Pilot off ● Pilot on	Green	Pilot laser is turned on and off alternately, if no target or outside the measuring range

1) The maximum thickness for a air gap is 2.1 mm. The thickness for glass ($n = 1.5$) is $35 \mu\text{m}$ as a minimum and 1.4 mm as a maximum.

6.6 Presets, Setups, Measurement Configuration, Signal Quality

Definition

- **Preset:** Manufacturer-specific program with settings for frequent measuring tasks; cannot be overwritten. You can select a preset in the tab `Home > Measurement configuration`.
- **Setup:** User-specific program with relevant settings for a measuring task. You can select a setup in the tab
 - `Home > Measurement configuration` or
 - **Settings in the** `System settings > Load & Save > Measurement settings` menu.
- **Initial setup at boot (sensor start):** a favorite can be selected from the setups, which is automatically activated at sensor start. If no favorite is determined from the setups, the sensor activates the `Standard` preset at startup.

With delivery of the sensor from the factory

- the presets `Silicon one layer` and `Si p plus plus` are possible,
- no setup is available.

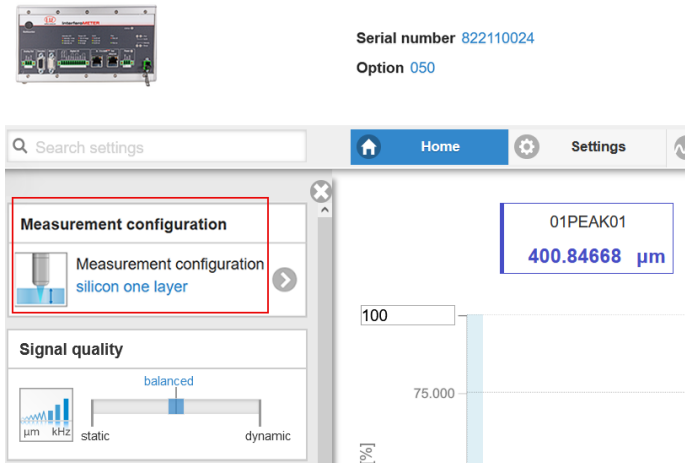

Common measurement configurations (presets) for various target surfaces are stored on the controller. This allows you to quickly start with your individual measurement task. In a preset the basic features like peak or material selection and calculation functions are already set.



The signal quality is set to `Balanced` at the factory.

➡ Go to the `Home > Measurement configuration` menu and start the configuration selection. Select a stored configuration (preset).

Subsequent you will find an overview of all possible presets:

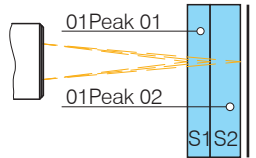
Presets		IMS5420-TH IMS5420IP67-TH	IMS5420MP-TH
 silicon one layer Thickness measurement for silicon. Moving average over 16 values.		•	•
 silicon p plus plus Thickness measurement for highly doped silicon. Moving average over 16 values.		•	•
 silicon two layers Two peaks are evaluated, layer 1 and 2 = silicon, layer 3 = air calibration Ethernet data output: - 01PEAK01, 01PEAK02 All output values incl. moving average over 16 values.	 Peak numbering applies for: layer 1 (S1) < layer 2 (S2)		•

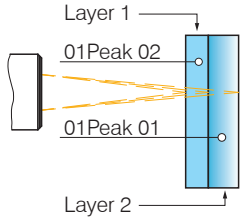
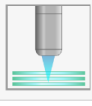
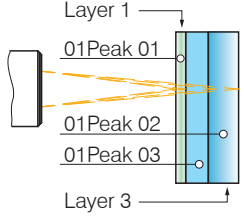
Presets		IMS5420-TH IMS5420IP67-TH	IMS5420MP-TH
 <p>multilayer silicon air</p>	<p>Silicon and air gap</p> <p>Two peaks are evaluated, layer 1 = silicon, layer 2 and 3 = air calibration</p> <p>Ethernet data output: - 01PEAK01, 01PEAK02</p>		•
Observe or change material selection			
 <p>multilayer paste silicon</p>	<p>Paste and silicon</p> <p>Two peaks are evaluated, layer 1 = water, layer 2 = silicon, layer 3 = air calibration</p> <p>Ethernet data output: - 01PEAK01, 01PEAK02</p>	 <p>Peak numbering applies for: layer 1 < layer 2 < layer 3</p> <p>Set data output</p>	•

- possible preset

Then, you can apply your own settings. When saving a changed preset, the web interface displays a dialog which enables the user to define a setup name. This prevents presets from being overwritten by accident.

Using the `Signal quality` function, you can influence the measuring rate and the respective averaging for all presets.

Averaging with the `Median` function is specified by the preset.

The subsequent moving averaging is specified by the `Signal quality` function.

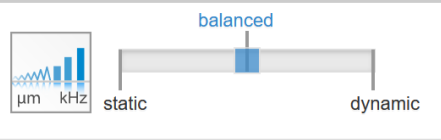
Signal quality	Averaging, measuring rate	Description
	<p>Static</p> <p>Moving with 128 values</p> <p>Measuring rate 0.2 kHz</p>	<p>In the signal quality section, you can switch between three basic settings (static, balanced and dynamic). The reaction in the chart and system configuration is immediately visible.</p> <p>! If the controller starts up with a user-defined measurement setting (preset), the signal quality cannot be changed.</p>
	<p>Balanced</p> <p>Moving with 16 values</p> <p>Measuring rate 1 kHz</p>	
	<p>Dynamic</p> <p>Moving with 4 values</p> <p>Measuring rate 6 kHz</p>	

Individual material selection is possible in the `Settings > Data recording > Material selection` menu.

Conventional measurement configurations (presets) for various target surfaces are saved in the controller. They allow for a quick start in the individual measuring task. Basic features such as peak and material selection and the calculation functions are already set in the preset.

The signal quality is set to `Balanced` at the factory.

- ➡ Go to the `Home > Measurement configuration` menu and start the configuration selection. Select a configuration.

6.7 FFT Signal

➡ Go to the `Measurement` chart menu. Show FFT signal display with `FFT`.

The signal in the chart window shows the thickness of the measured layers or the target thickness.

Left 0 % (thin target or layer), and right 100 % (thick target or layer). The corresponding measured value is marked by a vertical line (peak marking). The diagram starts automatically when the website is called. 100 % intensity corresponds to the value 2048.

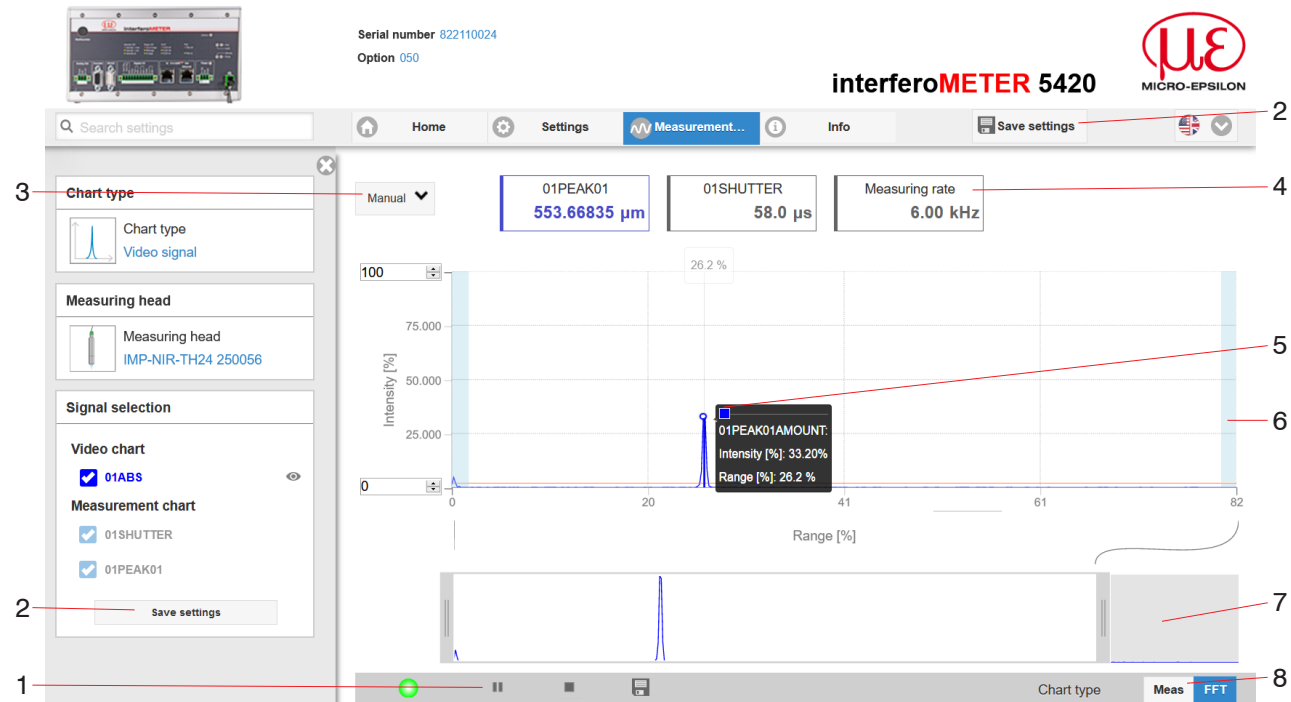

Fig. 37 FFT signal web page

The `FFT` web page includes the following features:

1 The LED visualizes the status of the transmission of measured values:

- green: transmission of measured values is running.
- yellow: waiting for data in trigger mode
- gray: transmission of measured values stopped

Data queries are controlled by using the `Play/Pause/Stop/Save` buttons of the measured values that were transmitted. `Stop` stops the diagram; data selection and zoom function are still possible. `Pause` interrupts recording. `Save` opens the Windows dialog box for the name and the location of the file in order to save the selected FFT signals or correction tables in a CSV file, which contains all pixels, their (selected) intensities in % and other parameters.

➡ Click the button ▶ (Start), for starting the display of the measurement results.

2 Changes only take effect after clicking the `Save settings` button.

3 For scaling the intensity axis (y-axis) of the graphic, you can either select `Auto` (= autoscaling) or `Manual` (= manual setting).

4 In addition, the current exposure time values and the measuring rate are displayed above the graph.

5 Mouseover feature. When moving the mouse over the graph, curve points or peak markings are highlighted with a circle symbol while the corresponding intensity is displayed. The related x position is displayed in % above the graph window.

6 The masked range may be limited if needed. Then an additional pale blue hatching limits the range on the right and on the left side. The peaks remaining in the resulting range are used for evaluation.

- 7 X axis scaling: The diagram displayed above is zoomable with both sliders on the right and on the left side in the lower total signal. It can also be moved with the mouse in the center of the zoom window (arrow cross).



Fig. 38 Slider zoom: one-sided and dragging with cross arrow

- 8 The two buttons allow to switch between FFT signal and measurement representation.

6.8 Thickness Measurement with Web Page Display

- ▶ Align the sensor vertically to the target object.
- ▶ Then, move the sensor (or the target) closer, until you more or less reach the start of measuring range for your sensor.

Once the object is within the sensor's measuring range, the **Range LED** (green or yellow) on the front of the controller will light up. Or, observe the FFT signal.

LED	State	Description
Intensity	Red	Signal in saturation
	Yellow	Signal too low
	Green	Signal ok
Range	Red	No target or outside the operating range
	Yellow	Target in mid of working distance
	Green	Target within the operating range

Fig. 39 Description of LEDs for thickness measurements

Opening the **Measurement chart > Meas** displays the following web page. The diagram starts automatically when the web page is called up. The diagram in the large graph window to the right displays the value-time graph.

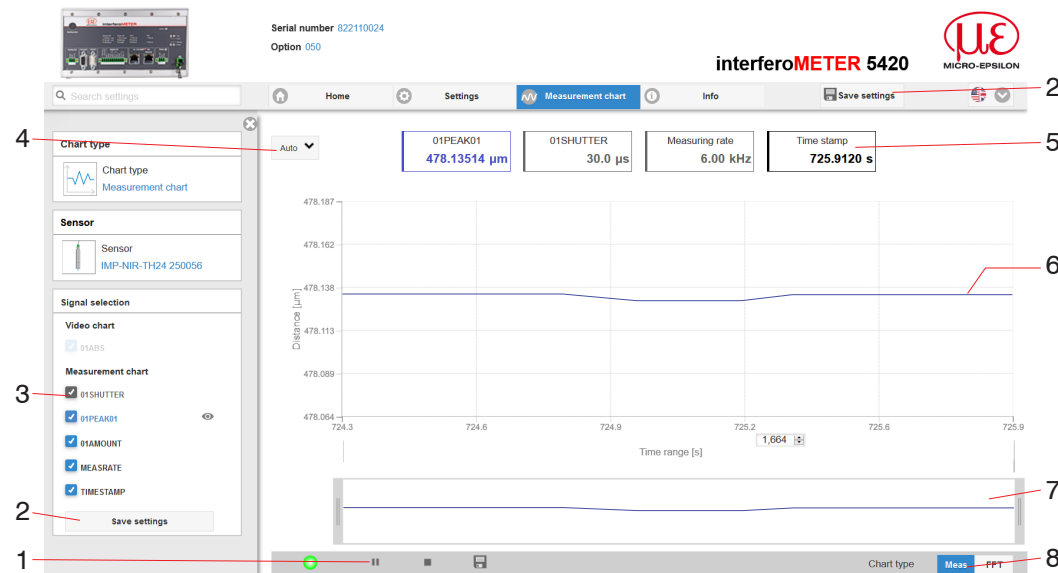

Fig. 40 Measurement web page (thickness measurement)

- 1 The LED visualizes the status of the transmission of measured values:
 - green: transmission of measured values is running.
 - yellow: waiting for data in trigger mode
 - gray: transmission of measured values stopped

Data queries are controlled by using the **Play/Pause/Stop/Save** buttons of the measured values that were transmitted. **Stop** stops the diagram; data selection and zoom function are still possible. **Pause** interrupts recording. **Save** opens the Windows selection dialog for file name and storage location to save the last 10,000 values in a CSV file (separation with semicolon).

- ▶ Click the button ▶ (Start), for starting the display of the measurement results.
- 2 Changes only take effect after clicking the **Save settings** button.
 - 3 In the window on the left, the signals can be enabled or disabled both during and after the measurement. Inactive graphs are gray. Click on the check mark to add them. The changes take effect when saving the settings. Use the eye symbols to show and hide the single signals. The calculation continues in the background.
 - 01PEAK01: Chronological sequence of thickness signal
 - 4 **Auto** (= automatic scaling) or **Manual** (= manual setting) allow for scaling the measurement axis (Y axis) of the graphic.
 - 5 The current values for thickness, exposure time, current measuring rate and time stamp are displayed in the text boxes above the graphic. Errors are displayed as well.
 - 6 Mouseover feature. When moving the mouse over the graph, curve points are highlighted with a circle symbol while the corresponding values are displayed in the text boxes above the graph.

- 7 X axis scaling: The total signal is zoomable with the slider on the left side during running measurement. The time range can be defined in the input field below the time axis. If the diagram is stopped, you can also use the right slider. The zoom window can also be moved with the mouse in the center of the zoom window (arrow cross).
- 8 The two buttons allow to switch between FFT signal and measurement representation.

6.9 Load / Save Settings

In this menu you can save current device settings to the controller and recall stored settings. You can permanently store eight different parameter sets in the controller.

Unsaved settings are lost when the device is switched off. Save your settings in setups.

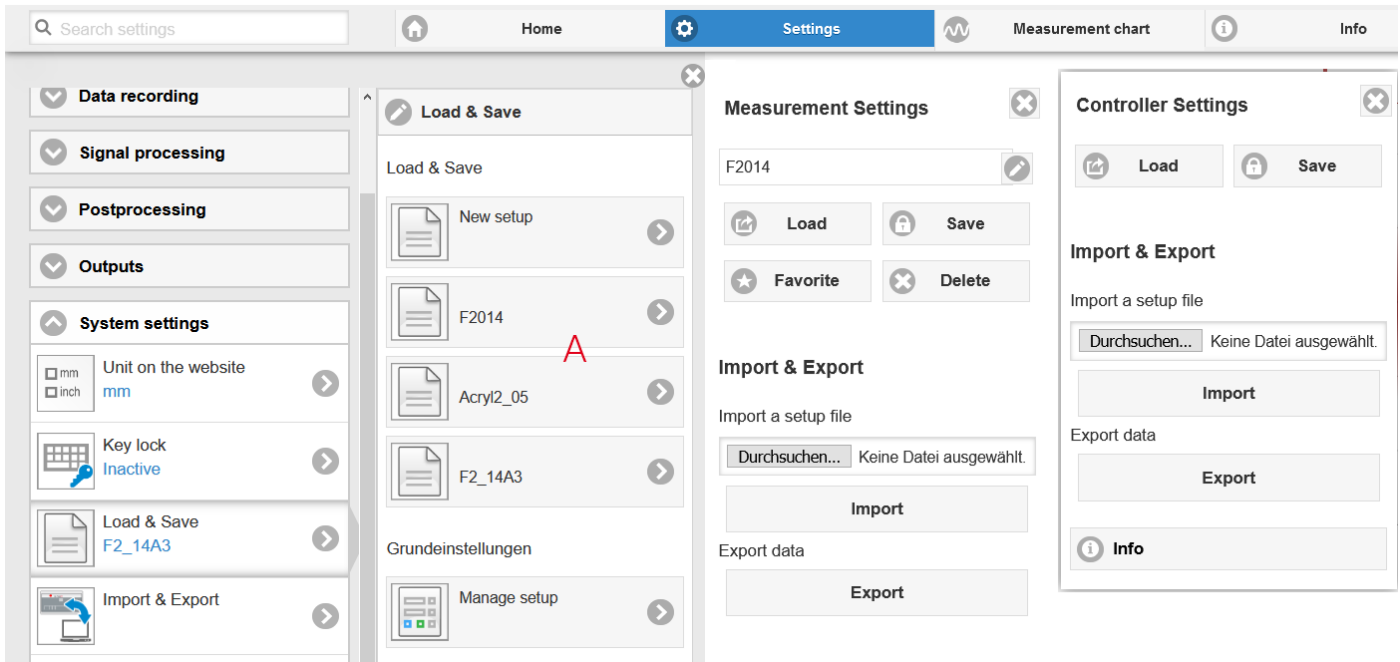
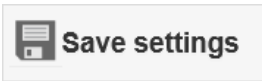



Fig. 41 Setup management

➡ Change to the Settings > System settings > Load & Safe menu.

Manage setups in the controller, possibilities and procedure			
Saving the Settings	Activate existing setup	Save changes in active setup	Define setup after booting
New setup menu	Load & Safe menu	Menu bar	Load & Safe menu
➡ Define the setup name in the field <input style="width: 100px; height: 15px; border: 1px solid #ccc;" type="text" value="Individual setup name"/> , e.g., Acryl2_05, and confirm the entry by clicking the Save button.	➡ Click on the desired setup with the left mouse button, area A. The Measurement settings dialog opens. ➡ Click the Load button.	➡ Click the button  	➡ Click on the desired setup with the left mouse button, area A. The Measurement settings dialog opens. ➡ Click the Favorite button.

The current settings will be available in the controller after it has been switched off/on.

You can also use the Save Setup button at the top right on every settings page for fast intermediate saving to the last saved parameter set.

i Switching on the controller loads the set of parameters that was last stored in the controller.

Exchange setups with PC/notebook, possibilities	
Save setup on PC	Load setup from PC
Load & Safe menu	Load & Safe menu
➡ Click on the desired setup with the left mouse button, area A. The Measurement settings dialog opens. ➡ Click the Export button.	➡ Click on the desired setup with the left mouse button, area A. The Measurement settings dialog opens. ➡ Click the Search button. A Windows dialog for file selections opens. ➡ Choose the desired file and click on the button Open. ➡ Click the Import button

7. Advanced Settings

7.1 Inputs

7.1.1 Synchronization

In case several sensors should measure the same target synchronously, you can synchronize the controllers with each other. The sync output of the first controller `IMC5x00-Master` is connected to the sync inputs of further controllers, see [Chap. 5.7.9](#).

<i>Master</i>	<i>First controller in the measuring chain; synchronizes all subsequent controllers.</i>
<i>Slave Sync/Trig</i>	<i>Controller operates in dependence on the first controller. The input expects TTL or HTL level.</i>
<i>Slave TrigIn</i>	<i>The input expects TTL or HTL level and enables external synchronization. The TrigIn input is controlled by an external synchronization source, e.g., a frequency generator. Min. 0.1 ... 6 kHz. It is also possible to simultaneously synchronize multiple controllers externally.</i>

If the controllers are operated using an EtherCAT interface, synchronization must be performed via EtherCAT.

7.1.2 Encoder

A maximum of two¹ encoder values can be assigned to the measured data. They will then be issued and used as trigger conditions. This exact assignment to the measured values is ensured by the fact that exactly the encoder values are output that are exist in half of the exposure time of the measured value (the exposure time may vary due to the control). Tracks A and B make it possible to detect directions. Each of the three encoders can be configured separately. The encoder socket configuration, see [Chap. 5.7.11](#).

<i>Encoder 1 / 2</i>	Interpolation	<i>single / double / quadruple resolution</i>
	Max value	<i>Value</i>
	Effect on reference track	<i>no effect / set on first track / set with every track</i>
	Set on value	<i>Value</i>
	Setting encoder value per software	
	Reset the detection of the first marker position	

7.1.3 Key Function

The `Multifunction` button of the controller has multiple functions. Detailed information is available in the Multifunction section, see [Chap. 6.4](#).

7.1.4 Input Level

For the `TrigIn` digital input, the logic level must be defined with which it is controlled.

<i>Input level</i>	<i>TTL / HTL</i>	<i>TTL: Low ≤ 0.8 V, High ≥ 2 V HTL: Low ≤ 3 V, High ≥ 8 V</i>
--------------------	------------------	--

7.1.5 Termination

For the `Sync/Trig` digital input, the terminating resistor in the operating mode `Synchronization > Slave` in the last controller of the series must be switched on.

Termination	on / off	<i>The terminating resistor avoids reflections.</i>
-------------	----------	---

1) The reference tracks can be used as a third encoder, see [Chap. 5.7.11](#).

7.2 Data Recording

7.2.1 Measuring Rate

The measuring rate can be selected in the `Settings > Data recording > Measuring rate` menu.

➤ Select the required measuring rate.

The measuring rate can be adjusted in a range from 0.1 kHz to 6 kHz in increments of 100 Hz.

Procedure:

➤ Position the target (measurement object) as much as possible in the mid of the operating range. Adjust the measuring rate until you receive a stable signal over the entire measuring range that is not oversaturated.

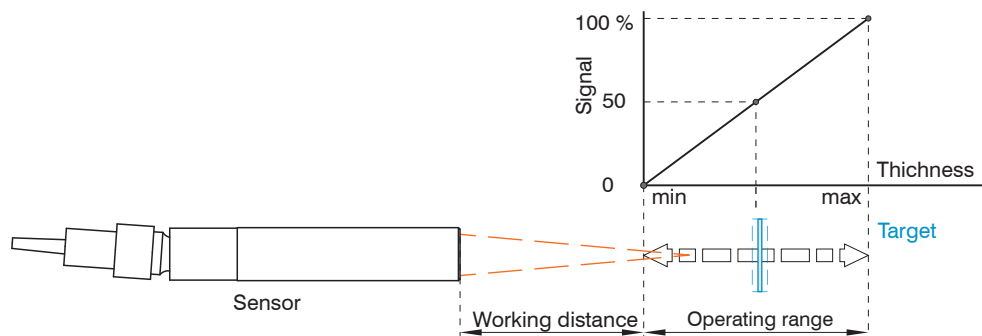

Fig. 42 Defining measuring range and output signal

➤ To do this, observe the `Intensity LED`.

LED	State	Description	
Intensity	Red	Permanent	Raw signal is saturated or no peak selectable
	Yellow		Peak can be analyzed, but at reduced linearity
	Green		Peak can be analyzed, specified measured result

➤ Select the measuring rate so that the `Intensity LED` lights up green.

➤ If necessary, change the exposure mode, use the `Manual` mode, see [Chap. 7.2.3](#).

➤ Use the required measuring rate and adjust the exposure time. Otherwise, the exposure time defines the possible measuring rate.

If the signal is low (`Intensity LED` lights up yellow) or saturated (`Intensity LED` lights up red), the controller performs measurements, but the measurement accuracy might not correspond to the specified technical data.

7.2.2 Masking the Evaluation Range

With the interfeRoMETER, the user can set an individual evaluation range.

The evaluation range can be selected in the `Settings > Data recording > Evaluation range` menu.

Masking limits the range that the FFT uses for thickness measurement.

This function is used to mask the background, if it extends into the measuring range.

Evaluation range	Start of range in %	<i>Value</i>
	End of range in %	<i>Value</i>

Masking (start of range/end of range) is entered into the two boxes on the left (in %).

i If you limit the evaluation range, a peak is detected only if it is completely within the evaluation range and above the threshold. This might reduce the measuring range.

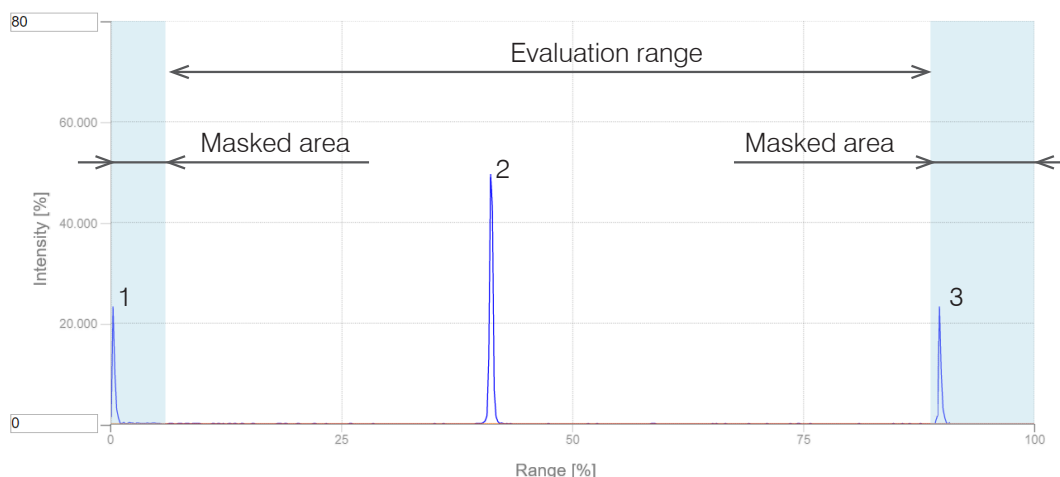

Fig. 43 Limiting the used FFT signal

The example shown in the figure uses the peak (2) for the evaluation, while peaks (1) and (3) are not used.

 Set the desired evaluation range.

7.2.3 Exposure Mode

With the interfeRoMETER, the exposure mode can be set.

The specified or appropriate measuring rate is maintained and only the exposure time is controlled. A smaller control range is used to achieve faster results. Differently reflecting targets can also be measured using the same measuring rate here.

7.2.4 Detection Threshold

The detection threshold (in digits relative to the magnitude signal) defines the minimum signal quality for including an FFT signal peak in the analysis. The controller evaluates the highest peak. Therefore, the FFT graph must be taken into consideration when defining the threshold.

Detection threshold in %	Value
--------------------------	-------

Defining detection threshold: In general, set the threshold high enough to avoid that any interfering peaks are detected.

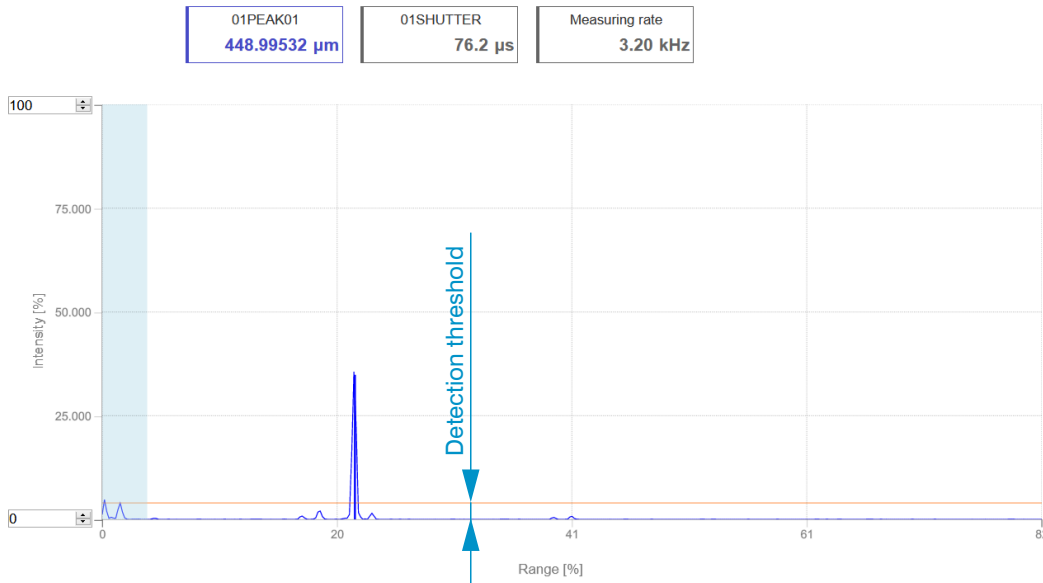

Fig. 44 Measurement with secondary peaks in a material that is not optically dense

• Peaks von hochdotiertem Silizium weisen typisch geringe Intensitäten aus. Reduzieren Sie bei Bedarf die Erkennungsschwelle, damit diese Peaks in der Auswertung berücksichtigt werden.

7.2.5 Measpeak Sorting

The selection of peak/peaks dictates which region in the signal is used for the thickness measurement.

- Switch to material selection by going to Settings > Data recording.
- Switch to the chart type FFT.
- Choose between First peak and Highest peak.

Controller IMC5420-TH and IMC5420IP67-TH24	
Thickness	
<p>The IMS5420-THxx evaluates one layer.</p> <p>The peak in the FFT signal already corresponds to the thickness. It is not necessary to decide between the first and highest peak.</p>	

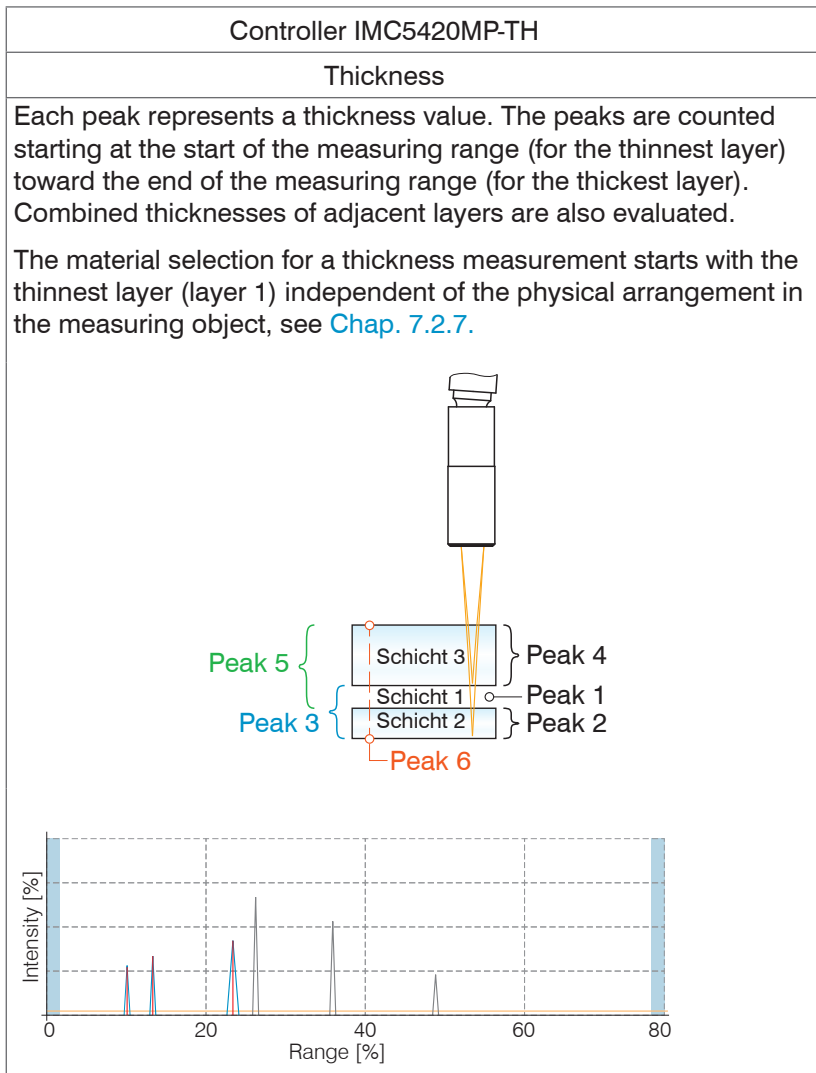

Fig. 45 Evaluation starts with the first peak, e.g. 3 out of 4 peaks

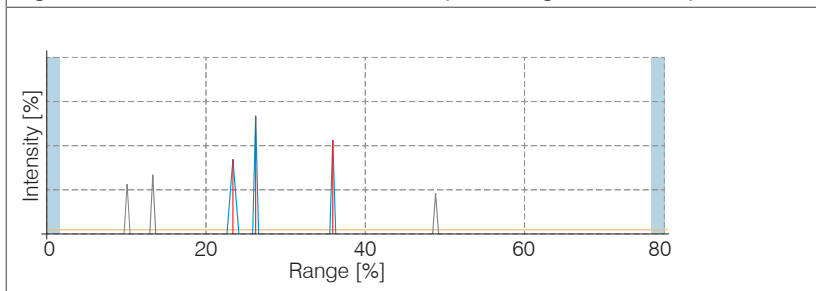

Fig. 46 Evaluation starts with the highest peak, e.g. 3 out of 4 peaks

The number of peaks of the FFT signal that are used for evaluation in thickness measurement are to be determined separately, see [Chap. 7.2.6](#).

In the case of a target consisting of several transparent layers, the material must be assigned for each layer, see [Chap. 7.2.7](#).

i This function is used if, before or between the useful peaks, a material has even smaller interfering peaks caused by thin layers on the target. This function should be used with caution and should only be used by product specialists.

7.2.6 Number of Peaks

Number of peaks of the FFT signal used for evaluation in thickness measurement. The number of peaks can be selected in the Settings > Data recording > Number of peaks menu.

This function is possible for the following system:

- IMS5420MP-TH: max. 5 layers

Make sure to count the peaks in the correct manner, see [Chap. 7.2.5](#).

The standard systems IMS5420-TH24 and IMS5420IP67-TH24 evaluate one layer.

Example of one layer through silicon and gap; measurement peak sorting: first

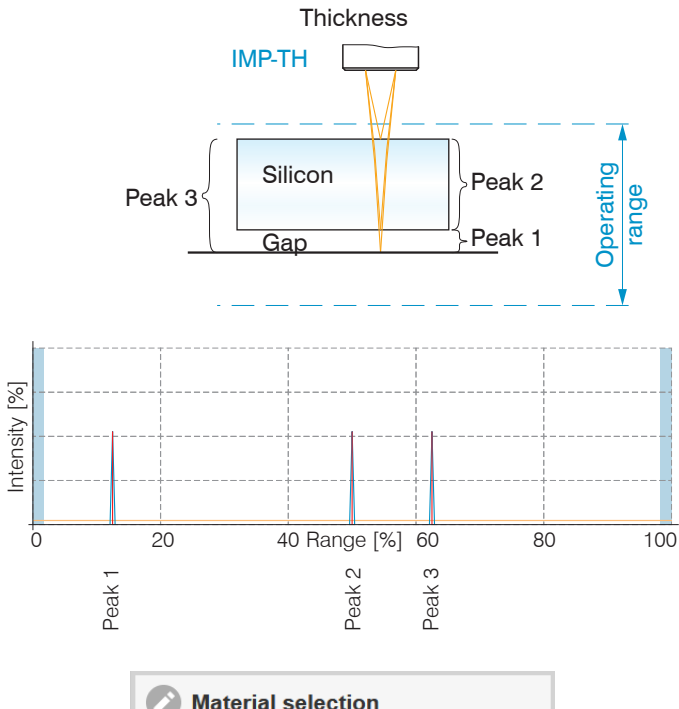

Material selection

Material Infront:

Layer 1:

Layer 2:

Layer 3:

Fig. 47 Measurement arrangement of two layers with corresponding material selection

The material selection for a thickness measurement starts with the thinnest layer (layer 1) independent of the physical arrangement in the measuring object.

A material does not necessarily have to be selected for layer 3. Peak 3 stands for a combination layer of silicon and air. The controller evaluates this layer; however, the result has no significance in the measurement.

Example of silicon with paste and gap, measurement peak sorting: First

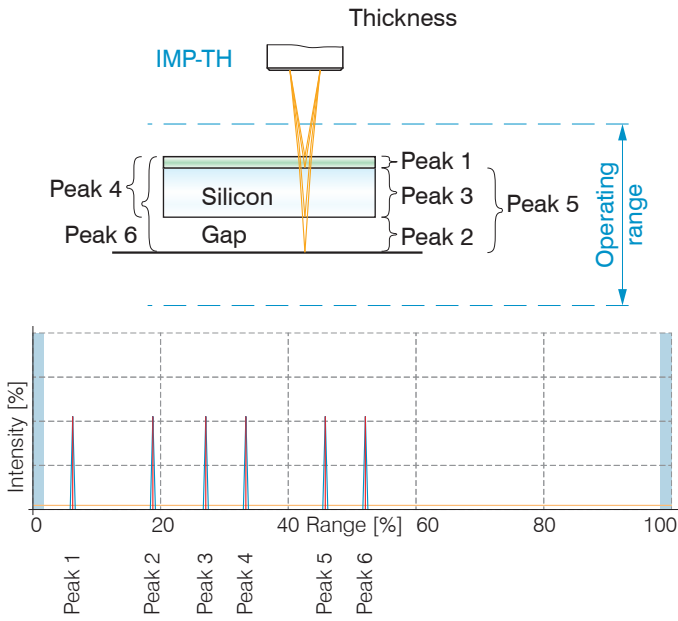

Material selection

Material Infront:

Layer 1:

Layer 2:

Layer 3:

Layer 4:

Layer 4 is the selected material for the combined layer¹ of Peak 4.

Fig. 48 Measurement arrangement of three layers with corresponding material selection

The IMS5420MP-TH24 controller can measure the thickness of combined layers of the same material. If the layers cannot be separated or if the layers consist of different materials, the thickness can be determined using the IMS5420MP-TH24 controller and signal processing (calculation programs).

A material does not necessarily have to be selected for layer 4. Peak 4 stands for a combination layer of paste and silicon. The controller evaluates this layer; however, the result has no significance in the measurement.

1) The IMS5420MP-TH24 controller also evaluate combined thicknesses of different layers.

7.2.7 Material Selection

The refractive index needs to be corrected in the controller for an exact thickness measurement. Only air or vacuum may be present between the sensor face and the measuring object (Material Infront); other media such as water or alcohol are not permissible.

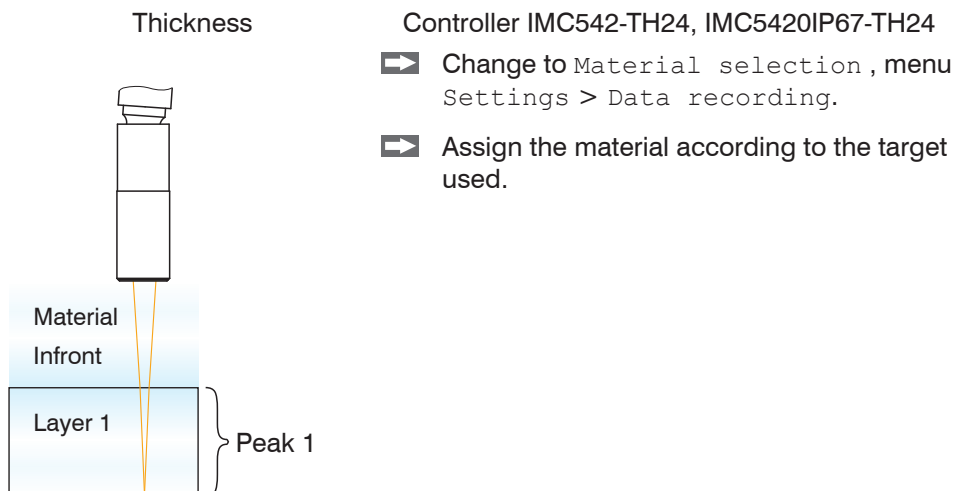

You can edit or add to the material table. For a new material, a phase index and group refractive index is required.

➡ Switch to the link material table by going to Settings > Data recording.

material name	phase index	Group refractive index	phase shift	description
Air calibration	1.000262	1.000264	0.000000	Calibration material
Vacuum calibration	1.000000	1.000000	0.000000	Calibration material
Silicon calibration	3.545000	3.825245	0.000000	Calibration material, 20.75degC, 1096.68nm
Vacuum	1.000000	1.000000	0.000000	Perfect vacuum
Air	1.000274	1.000276	0.000000	1100 nm, laboratory conditions, Ciddor et al. 1996
Silicon	3.545000	3.820000	0.000000	1100 nm, laboratory conditions, Schinke et al. 2015
Water	1.324000	1.340500	0.000000	1100 nm, 20degC, Daimon and Mesura et al. 2007

Fig. 49 Materials selection of measuring object

The surface area of the following material is also required for calculating the thicknesses.

- Click the icon to change an existing entry.
- Click the icon to add another material.
- Click the icon to save another or changed material.
- Click the icon to cancel the operation without saving.
- Click the icon to delete the entry.

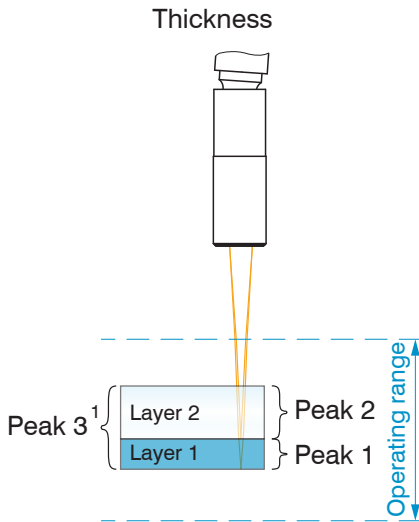

Controller IMC5420MP-TH24

- ➡ Change to Material selection, menu Settings > Data recording.
- ➡ Assign the materials to the individual layers according to the target used.

Material selection

Material Infront:

Layer 1:

Layer 2:

The material selection for a thickness measurement starts with the thinnest layer (layer 1) independent of the physical arrangement in the measuring object.

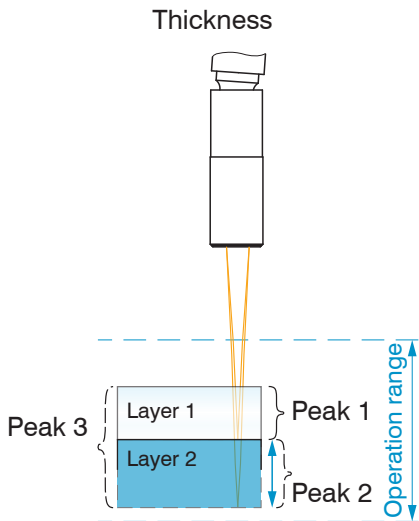

Controller IMC5420MP-TH24

Compared to the example above, the thickness of the lower layer (blue) has increased and is larger than the upper layer. For this case, the material selection must be adjusted.

In the FFT signal, peak 1 and peak 2 change places, see [Chap. 6.8](#), see [Chap. 7.2.5](#).

Material selection

Material Infront:

Layer 1:

Layer 2:

1) The IMS5420MP-TH24 controller also evaluate combined thicknesses of different layers. For peak 3, a material must be selected accordingly for layer 3 (= layer 1 + layer 2).

7.2.8 Triggering

7.2.8.1 General

Measured value input or output by the interfeRoMETER can be controlled using an external electrical trigger signal or commands. Both analog and digital outputs are affected by this.

- Triggering does not affect the specified measuring rate.
- As external trigger inputs, `Sync/Trig` or `TrigIn` are used, see [Chap. 5.7.10](#).
- Factory settings: no triggering, the controller starts transmitting data as soon as it is switched on.
- The pulse of the trigger signal must be at least 5 μ s.

Trigger settings are performed in the `Settings > Data recording > Trigger data recording` menu. The triggering of the measured value recording and output have the same timing.

<i>Sync/Trig TrigIn</i>	Trigger type	<i>Level</i>	Trigger level	Low / High	
		<i>Edge</i>	Trigger level	falling edge / rising edge	
			Number of measured values	<i>Manual selection</i>	<i>Value</i>
<i>Software</i>	Number of measured values		<i>Manual selection</i>	<i>Value</i>	
	Start triggering		<i>infinite</i>		
<i>Encoder 1/2</i>			Lower limit	<i>Value</i>	
			Upper limit	<i>Value</i>	
			Step size	<i>Value</i>	
<i>Inactive</i>	<i>Continuous data recording</i>				

Level triggering. Continuous value input or output for as long as the selected level is active. Afterwards, the controller stops the input/output of the values. The duration of the pulse must be at least one cycle time. The subsequent pause must also be at least one cycle time.

U_1 = Trigger signal

W = Thickness signal

Fig. 50 Active high level trigger (U_1), relevant analog signal (A_0) and digital signal (D_0)

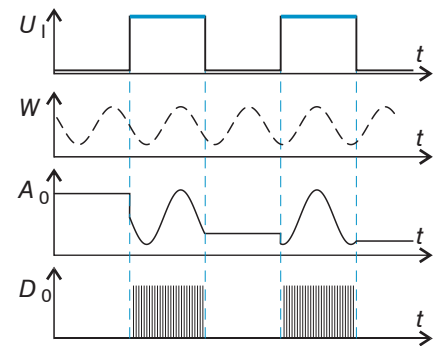

Edge triggering. Starts value input or output as soon as the selected edge is active to the trigger input. The number of recorded measurement values depends on the `Number of measured values` parameter. The duration of the pulse must be at least 5 μ s.

Fig. 51 Falling edge trigger (U_1), relevant analog signal (A_0) and digital signal (D_0)

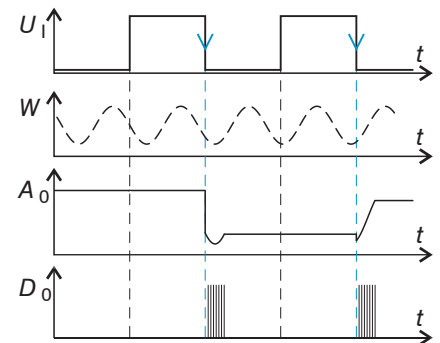

Software triggering. Starts value input or output as soon as a software command (instead of the trigger input) or the `Initiate trigger` button is activated. The point in time is not defined as accurately. If trigger conditions are met, the controller outputs a defined number of measurements. Value range between 1 and 16383. Value output can be stopped with a command, see [Chap. A 3.3.4.5](#).

Encoder triggering. One of the three encoder inputs can be used for triggering. When the trigger condition is met, the controller processes the measured values; the controller then waits for another trigger signal.

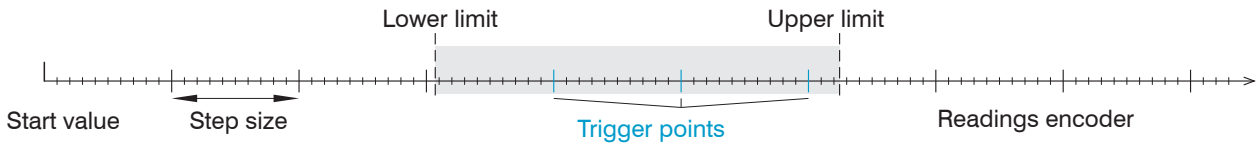

Fig. 52 Definition of terms for encoder triggering

i Within the step size there are no readings. Keep this, if measurement averaging is used.

7.2.8.2 Triggering Data Recording

The current array signal is only processed and measured values are calculated from it after a valid trigger event. After possible signal processing (e.g., average), the measured value data are then prepared for output via a digital or analog interface. When calculating averages, measured values immediately before the trigger event cannot be included; instead older measured values are used, which had been entered during previous trigger events.

7.2.8.3 Triggering Data Output

Measurement values are calculated continuously and independently of the trigger event. A trigger event simply triggers the value output via a digital or an analog interface.

Therefore, any values measured immediately before the trigger event are included in calculating mean values (averages) or statistics.

The measured value at the time of the trigger event is output with a delay.

7.2.8.4 Trigger Time Difference

Since the exposure time is not started directly by the trigger input, the respective time difference to the measurement cycle can be output. This measured value can, for example serve to accurately assign measurements to one place, when measuring objects are scanned at a constant speed and when each track starts with a trigger.

The time from the start of the cycle until the trigger event is defined as a trigger time difference. The output of the time determined occurs 5 cycles later, due to the internal processing.

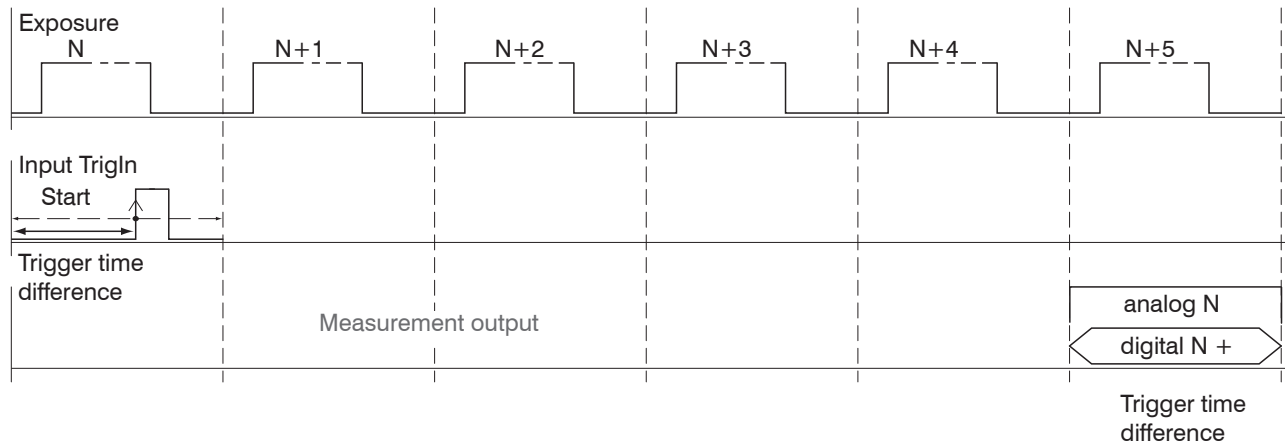

Fig. 53 Definition of the trigger time difference

i The start of the cycle does not mean the start of the exposure time. There is only a fixed difference of 100 ns between the start of the cycle and the end of the exposure time.

7.3 Signal Processing, Calculation

7.3.1 Data Source, Parameter, Programs

One calculation operation can be performed in each calculation block. To do so, you must adjust the calculation program, the data sources and the program parameters.

		IMS5x-TH IMS5xIP67-TH	IMS5xMP-TH
Median		•	•
Moving Average		•	•
Recursive Average		•	•
Thickness	Calculating the difference	Two signals or results, peak/result B < peak/result A	•
Formula		Peak A - Peak B	
Calculation	Summation	Two signals or results	•
Formula		Factor 1 * peak/result A + factor 2 * peak/result B + offset	
Duplicate	Creates a copy of a signal		•

Fig. 54 Available programs, • = possible function

➤ Select a program ①, e.g. average

➤ Define the parameter ②.

➤ Define the data source(s) ③.

➤ Enter a block name ④.

➤ Click on the button Store calculation.

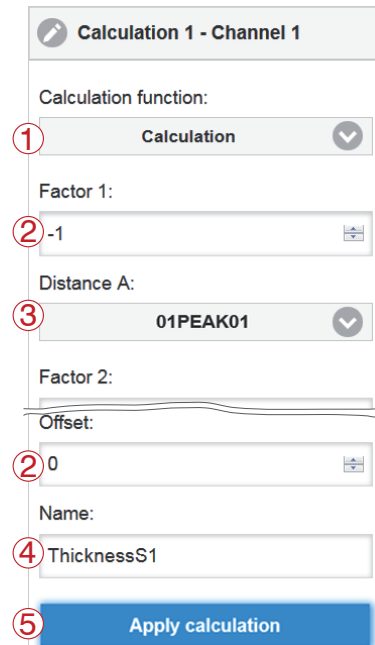

Fig. 55 Sequence for creating a calculation block

The programs calculation and thickness have two data sources. Averaging programs each have one data source.

Calculation parameters (Calculation)	Factor 1 / 2	Value	-32768.0 ... +32767.0
	Offset	Value	-21.47 ... 21.47
Calculation parameters (Averaging)	Average type	Recursive / Moving / Median	
	Number of values	Value	Recursive: 2 ... 32000
			Moving: 2 / 4 / 8 / 16 / 32 / 64 / 128 / 256 / 512 / 1024 / 2048 / 4096
		Median: 3 / 5 / 7 / 9	

The number of values states over how many sequential measured values in the controller should be averaged before a new measured value is output.

7.3.2 Definitions

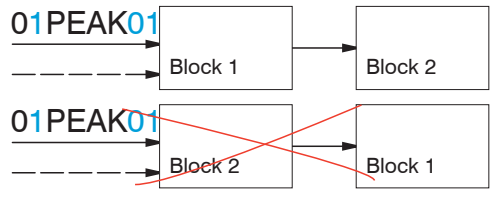
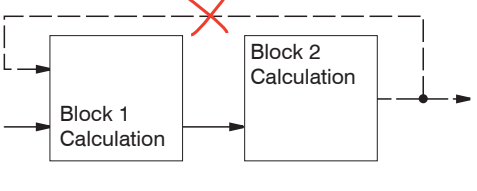
<p>A maximum of 10 calculation blocks are possible. The calculation blocks are processed sequentially.</p>	
<p>Feedback couplings (algebraic loops) over one or several blocks are not possible. Only the thickness values or the calculated result from the previous calculation block can be used as data source.</p>	
<p>Processing sequence</p> <ol style="list-style-type: none"> 1. Unlinearized thickness 2. Linearization of thickness 3. Refractive correction of thickness 4. Error handling in the case of no valid measured value 5. Calculation 6. Mastering 7. Statistics 	

7.3.3 Measurement Averaging

Measured value averaging is performed after measurement values have been calculated, and before they are output via the interfaces or their further processing.

Measured value averaging

- improves the resolution,
- allows masking individual interference points or
- "smoothes" the measurement result.

i The linearity behavior is not affected by averaging. Averaging has no effect on measuring rate and output rate.

The internal average value is recalculated in each measuring cycle.

i The defined type of average value and the number of values must be stored in the controller to ensure they are hold after it is switched off.

The controller is delivered with "moving average, averaging depth = 4" as factory settings, i.e. including averaging.

7.3.3.1 Moving average

The definable number N for successive measurements (window width) is used to calculate the arithmetic average M_{mov} according to the following formula:

$$M_{mov} = \frac{\sum_{k=1}^N MV(k)}{N}$$

MW measured value
 N averaging number
 c continuous index (in the window)
 M_{mov} average value or output value

Each new measured value is added, the first (oldest) measured value is removed from the averaging (from the window) again. In this way, it is possible to achieve short transition response times with measured value jumps.

Example: $N = 4$

... 0, 1, 2, 2, 1, 3

$$\frac{2, 2, 1, 3}{4} = M_{mov}(n)$$

... 1, 2, 2, 1, 3, 4

$$\frac{2, 1, 3, 4}{4} = M_{mov}(n+1)$$

Measured values

Output value

i Moving average in the controller allows only powers of 2 for the averaging number N . The highest averaging number is 4096.

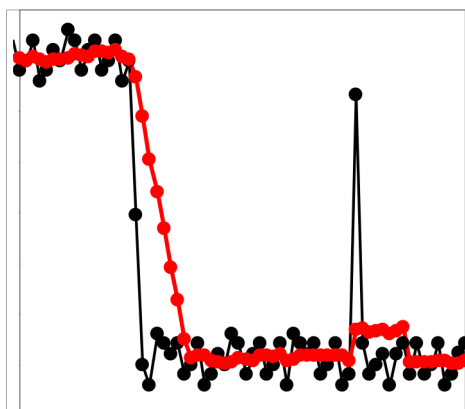

— Signal without averaging
 — Signal with averaging

Application tips:

- Smoothing of measured values
- Compared to the recursive average, the effect can be dosed more precisely
- With uniform noise of the measured values without spikes
- If the surface is only slightly rough, roughness can be eliminated
- Also suitable for measured value jumps at relatively low settling time

Fig. 56 Moving average, $N = 8$

7.3.3.2 Recursive average

Formula:

$$M_{rec}(n) = \frac{MV(n) + (N-1) \times M_{rec}(n-1)}{N}$$

MW measured value
 N averaging value, $N = 1 \dots 32768$
 n measured value index
 M_{rec} average value or output value

The weighted value of each new measured value $MV(n)$ is added to the sum of the previous average values $M_{rec}(n-1)$.

The recursive averaging enables very strong smoothing of the measured values, however it needs very long settling times for measured value jumps. The recursive average value shows low-pass behavior.

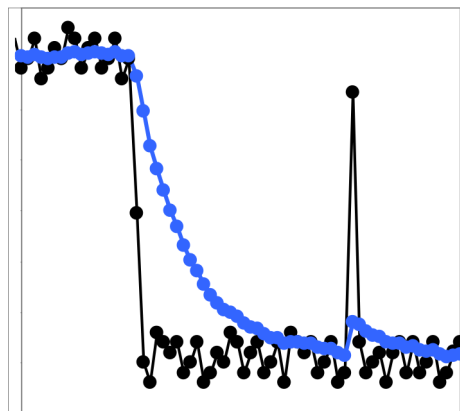

— Signal without averaging
 — Signal with averaging

Fig. 57 Recursive average, $N = 8$

Application tips:

- Allows very strong smoothing of the measured values. Long settling times for measured value jumps (low-pass behavior)
- Strong smoothing of noise without large spikes
- Well-suited for static measurements to smooth the signal noise particularly strongly
- For dynamic measurements on rough target surfaces to eliminate the roughness, e.g., paper roughness on paper webs
- To eliminate structures, e.g., targets with uniform groove structures, knurled turned parts or coarsely milled targets
- Not suitable for highly dynamic measurements

7.3.3.3 Median

The median of the selected number of measurements is calculated.

When the controller calculates the median, incoming measured values are also sorted again after each measurement. Afterwards, the mean value is output as the median.

3, 5, 7 or 9 readings are taken into account. This means that individual interference pulses can be suppressed. However, the smoothing of the measured value curves is not very strong.

Example: Median value from five measured values

... 0 1 2 4 5 1 3 → Sorted measurement values: 1 2 **3** 4 5 Median_(n) = 3
 ... 1 2 4 5 1 3 5 → Sorted measurement values: 1 3 **4** 5 5 Median_(n+1) = 4

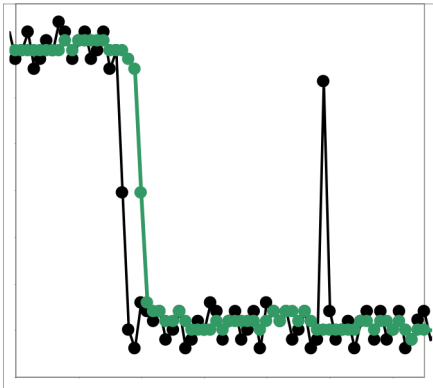

— Signal without averaging
 — Signal with averaging

Application tips

- Smoothing of the measured value curve is not very strong, used to eliminate outliers
- Suppresses individual interference pulses in short, strong signal peaks (spikes)
- Also suitable for edge jumps (only minor influence)
- For rough, dusty or dirty environment, to eliminate dirt or roughness
- Further averaging can be used after the median filter

Fig. 58 Median, N = 7

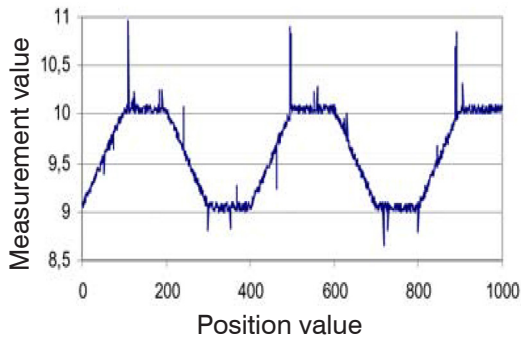

Fig. 59 Original profile

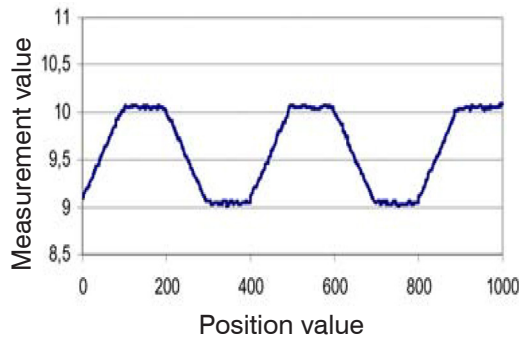

Fig. 60 Profile with median, N = 9

7.4 Postprocessing

7.4.1 Zeroing, Mastering

Use zeroing and setting masters to define a target value within the measuring range. This shifts the output range. This feature can be useful, for example, when several sensors carry out measurements simultaneously in thickness and planarity measurements. When measuring the thickness of a transparent target using the controller, define the actual thickness of a master object as `Master value`.

Master value in mm	Value	Specify the thickness (or other parameter) of a master object. Value range: -21.47 ... +21.47 mm (-0.845 ... +0.845 inch)
--------------------	-------	--

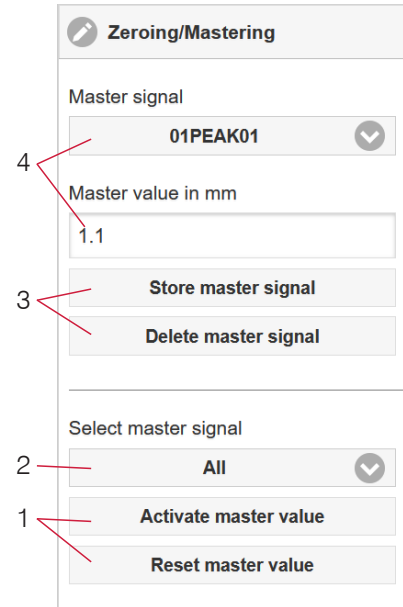

Mastering (setting masters) is used to compensate for mechanical tolerances in the sensor measurement setup or to correct chronological (thermal) changes to the measuring system. The master value, also called calibration value, is defined as the target value.

The `Master value` is the reading that is issued as result of measuring a master object. Zeroing is when you set a master with 0 (zero) as the master value.

i „Mastering“ or „Zeroing“ requires a target object in the measuring range. „Mastering“ and „Zeroing“ affect both the analog, switching and digital outputs.

- 1 Starts/stops the function
- 2 Applies a certain selected signal or function
- 3 Button for storing or deleting a master signal
- 4 Selects a signal for the function, assigns master value

Fig. 61 Mastering dialog, overview of individual master values

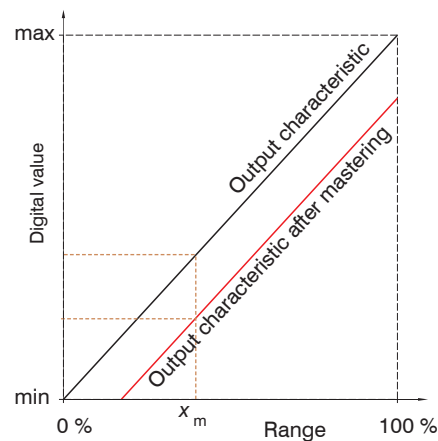

When setting a master, the output characteristic is moved in parallel. Moving the characteristic reduces the relevant measuring range of a sensor (the further master value and master position are located, the greater the reduction).

Setting masters/Zeroing – Step-by-Step:

- ➡ Place target and sensor into their required positions.
- ➡ Define the `Master value`, web interface/ASCII/EtherCAT.

After setting the master, the controller will issue new readings that relate to the master value. The `Reset master value` button resets the controller to the state before mastering.

Fig. 62 Moving the characteristic when mastering

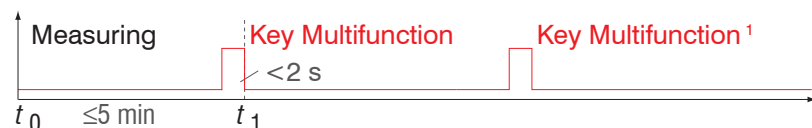

Fig. 63 Flow chart for zeroing, mastering (key Multifunction)

i The Select button is locked after 5 minutes by default. You can revoke the key lock using e.g., the web interface, see [Chap. 7.6.3](#).



Fig. 64 Flow chart for resetting zeroing/mastering

The zeroing/mastering function can be applied several times in a row.

1) The Multifunction key has no effect because the key lock is enabled.

7.4.2 Statistics

The controller derives the following statistical values from the measurement result:

- Minimum,
- Peak-to-Peak and
- Maximum

Statistical values are calculated from measured values within the evaluation range.

The evaluation range is reset for each new measured value. The statistical values are displayed in the web interface, measurement chart section, or are output via the interfaces.

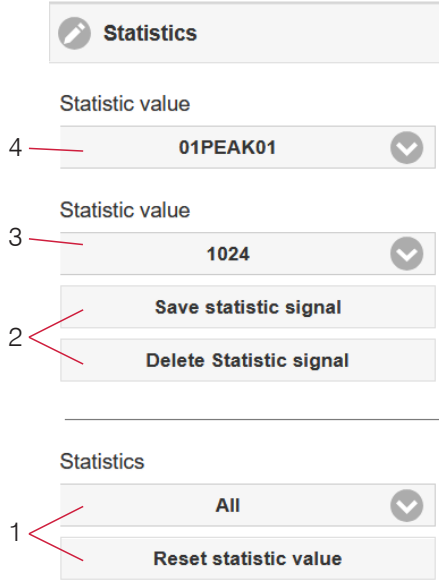

Fig. 65 Mastering dialog, overview of individual master values

- 1 Use the `Reset statistic value` button to reset a certain signal or all statistic signals in order to start a new evaluation cycle (storage period). When a new cycle starts, previous statistical values are deleted.
- 2 Button for saving or deleting a signal.
- 3 Number of measurement values based on which minimum, maximum and peak-to-peak are determined for a signal. The range of values used for calculation can be between 2 and 16384 (in powers of 2).
- 4 Selects a signal for the function.

Sequence for creating a statistical evaluation:

- Change to the tab `Settings > Postprocessing > Statistics`.
- Choose a signal (4) for which the statistical values should be calculated.
- Define the evaluation range via the `statistic value`.

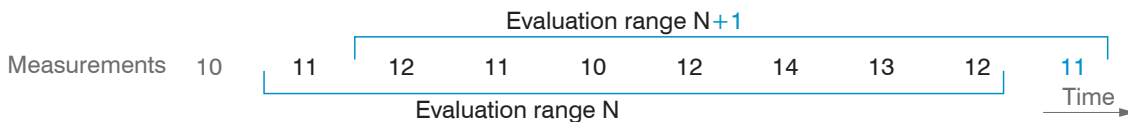

Fig. 66 Dynamic updating of the evaluation range using measured values, `statistic value = 8`

7.4.3 Data Reduction, Output Data Rate

Data reduction	<i>Value</i>	<i>Instructs the controller, which data are excluded from the output, and thus the amount of transmitted data is reduced.</i>
Reduction applies for	RS422 / Analog / Ethernet	<i>The interfaces, which are provided for the sub-sampling, are to be selected with the checkbox.</i>

You can reduce the measurement output in the controller if you set the output of every nth measurement value. Data reduction causes only every nth measured value to be output. All other measured values are discarded. The reduction value n can range from 1 (each measurement value) to 3,000,000. This allows you to adjust slower processes, such as a PLC, to the fast sensor without having to reduce the measuring rate.

7.4.4 Error Handling (Hold Last Value)

If no valid measured value can be determined, an error is output. If this is a problem for further processing, the last valid value can be retained for a certain period of time and will be output repeatedly.

Error handling	<i>Error output, no value</i>	<i>Instead of a value, interfaces output an error</i>	
	<i>Hold last value infinitely</i>	<i>Interfaces output the last valid value until a new, valid value is available</i>	
	<i>Hold last value</i>	<i>Value</i>	<i>Between 1 and 1024 values can be retained. If the number is 0, the last value is retained until a new, valid measured value appears.</i>

7.5 Outputs

7.5.1 General

A parallel data output via multiple channels is possible.

7.5.2 RS422

RS422	Baud rate	9,6 / 115,2 / 230,4 / 460,8 / 691,2 / 921,6 / 2000 / 3000 / 4000 kBps
	Signals	01ABS / 01SHUTTER / 01ENCODER1 / 01ENCODER2 / 01PEAK01 / ... / 01PEAK14 01AMOUNT / MEASRATE / TIMESTAMP / COUNTER / STATE / LAYER01 / GAP

The RS422 interface has a maximum baud rate of 4000 kBaud. As a factory setting, the baud rate is set to 115.2 kBaud. Use ASCII commands or the web interface to configure.

Transfer settings for controller and PC must match.

Data format: Binary. Interface parameters: 8 data bits, no parity, 1 stop bit (8N1). Selectable baud rate.

Using the RS422 interface, a minimum of 14 bits and a maximum of 32 bits are transmitted for each output value.

The maximum number of measured values that can be transferred for each measuring point depends on the controller measuring rate and the selected RS422 interface transmission rate. Where possible, use the maximum available transmission rate (baud rate).

The output sequence of individual signals within a data packet is fixed and is shown in the web interface.

7.5.3 Data Output Ethernet

The output data from all internally determined values and the calculated values from the calculation modules are selected separately for each of the two interfaces. This data is then output in a defined sequence. The selected values for Ethernet include the signals for the transfer of the measures values. However, this does not apply for the web diagram.

The screenshot displays the configuration interface for data output. On the left, a sidebar menu shows 'Outputs' expanded, with 'Data output Ethernet' selected. The main panel is titled 'Data output Ethernet' and contains a 'Signals' section with a list of 15 signals, each with a checkbox. The signals are: 01ABS, 01SHUTTER, 01ENCODER1, 01ENCODER2, 01PEAK01, 01PEAK02, 01PEAK03, 01AMOUNT, MEASRATE, TIMESTAMP, COUNTER, STATE, Layer01, and Gap. The checkboxes for 'Layer01' and 'Gap' are checked. Below the signals list is an 'Output sequence' section showing 'Layer01 Gap'.

Fig. 67 Selection of output data for the Ethernet interface, depending on controller version

7.5.4 Analog Output

Only one type of measurement can be transmitted at any given time. The analog output has a resolution of 16 bit.

Output signal	01PEAK01 / ... / 01PEAK14 / LAYER01 / GAP	It is possible to have only one output value output at the analog output.	
Output range	4 ... 20 mA / 0 ... 5 V / 0 ... 10 V	Either the voltage or the current output on the controller can be used.	
Scale	Standard scale	Scaling to 0 ... Measuring range	
	Two-point scale	Minimum value (in mm):	Value
		Maximum value (in mm):	Value

The first value corresponds to the start of the measuring range and the second value to the end of the measuring range. If the analog range needs to be moved, we recommend to use zeroing or mastering.

Two-point scaling allows for user-defined specification of the measuring range to be output. Here, switching the minimum and maximum range limits is permitted; this allows for a falling analog characteristic curve, see Fig. 68.

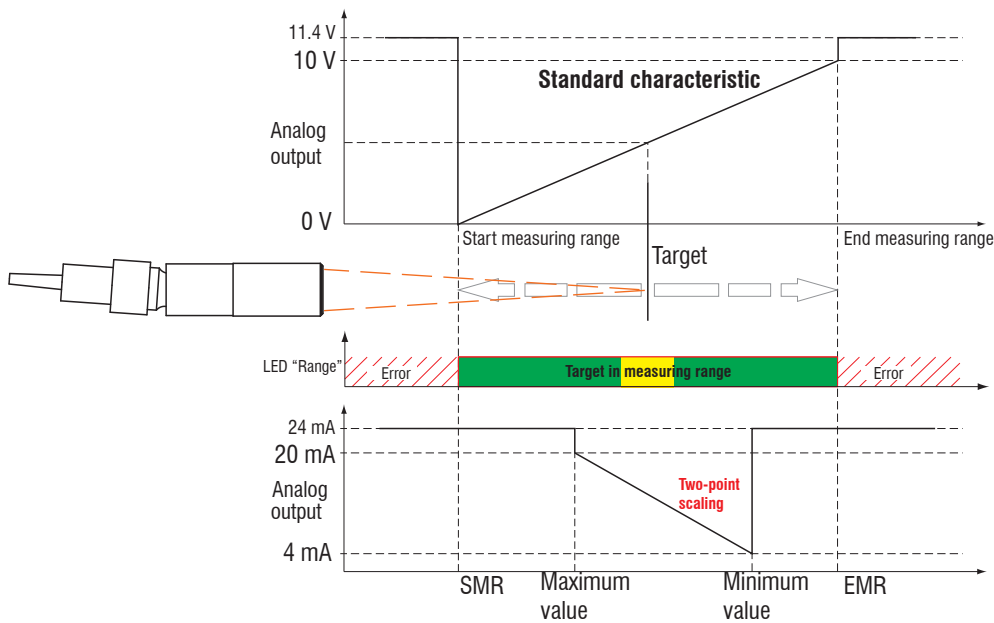

Fig. 68 Scaling the analog signal

7.5.4.1 Calculation of the Measurement Value at the Current Output

Current output (without mastering, without teaching)

Variables	Value range	Formula
I_{OUT} Current in mA	[3,8; <4] SMR reserve [4; 20] Measuring range [>20; 20,2] EMR reserve	$d = \frac{(I_{OUT} - 4)}{16} * MR$
MR Measuring range (thickness) in mm	{1.05 ¹ }	
d Thickness in mm	[-0,01MR; 1,01MR]	

Current output (with teaching)

Variables	Value range	Formula
I_{OUT} Current in mA	[3,8; <4] SMR reserve [4; 20] Measuring range [>20; 20,2] EMR reserve	$d = \frac{(I_{OUT} - 4)}{16} * n - m $
MR Measuring range (thickness) in mm	{1.05 ¹ }	
m, n Teaching area in mm	[0; MR]	
d Thickness in mm	[m; n]	

7.5.4.2 Calculation of the Measurement Value at the Voltage Output

Voltage output (without mastering, without teaching)

Variables	Value range	Formula
U_{OUT} Voltage in V	[-0,05; <0] SMR reserve [0; 5] Measuring range [>5; 5,05] EMR reserve	$d = \frac{U_{OUT}}{5} * MR$
	[-0,1; <0] SMR reserve [0; 10] Measuring range [>10; 10,1] EMR reserve	$d = \frac{U_{OUT}}{10} * MB$
MR Measuring range (thickness) in mm	{1.05 ¹ }	
d Thickness in mm	[-0,01MR; 1,01MR]	

Voltage output (with teaching)

Variables	Value range	Formula
U_{OUT} Voltage in V	[-0,05; <0] SMR reserve [0; 5] Measuring range [>5; 5,05] EMR reserve	$d = \frac{U_{OUT}}{5} * n - m $
	[-0,1; <0] SMR reserve [0; 10] Measuring range [>10; 10,1] EMR reserve	$d = \frac{U_{OUT}}{10} * n - m $
MR Measuring range (thickness) in mm	{1.05 ¹ }	
m, n Teaching area in mm	[0; MR]	
d Thickness in mm	[m; n]	

1) Measuring range thickness with n=3.82 (slicon); for air gap measurement between two glass plates (n~1) the measuring range is 0.2 ... 4 mm. The measurement object must be within the operating range.

7.5.5 Digital Outputs, Limit Value Monitoring

Digital output 1 „Error 1“	01PEAK01
Digital output 2 „Error 2“	
Compare to	Lower / upper / both
Limit value minimum in mm	Value
Limit value maximum in mm	Value
Switching level with error	PNP / NPN / Push-Pull / Push-Pull negated

Both switching outputs are activated if the target is located outside the measuring range.

Optionally, you can use the “Error 1” and “Error 2” switching outputs to monitor limit values. If a value falls above or below a limit value, the switching outputs are activated. Enter a lower and an upper limit value (in mm) for this purpose. Notes about switching behavior are available under electrical connections, .

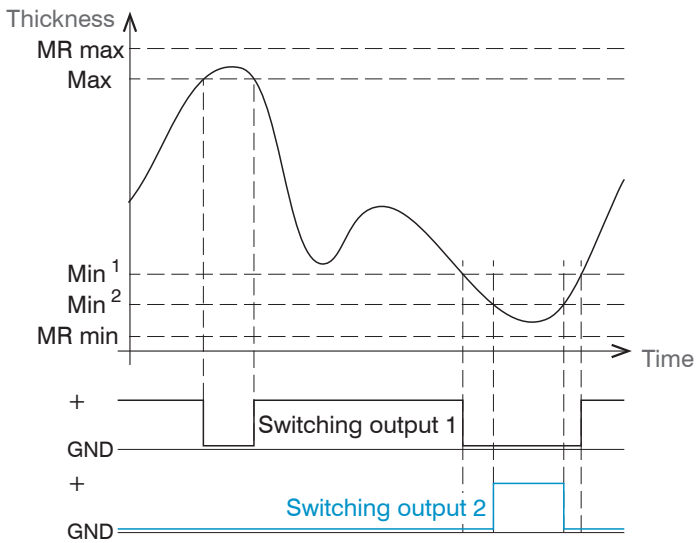

Range limit values
 -21,47 ... +21,47
 Max = Maximum
 Min¹ = Minimum switching output 1
 Min² = Minimum switching output 2
 MR = Measuring range, minimum and maximum

Fig. 69 Switching output 1 (both, NPN) and switching output 2 (lower, PNP) with limit values

7.5.6 Data Output, Interface Selection

The controller supports

- three digital interfaces that can be used in parallel for data output,
 - Ethernet: enables fast data transfer, but provides no real-time capabilities (packet-based data transfer). Both measurement and FFT data can be transferred. For measurement value detection without direct process control, for subsequent analysis. Parameterization is provided through the web interface or ASCII commands.
 - RS422: provides an interface capable of real-time output at a lower data rate.
 - Switching/limit value output
- Analog output: outputs either voltage or current values.

➡ Switch to the Settings > Outputs > Output interface menu and select the desired output channels.

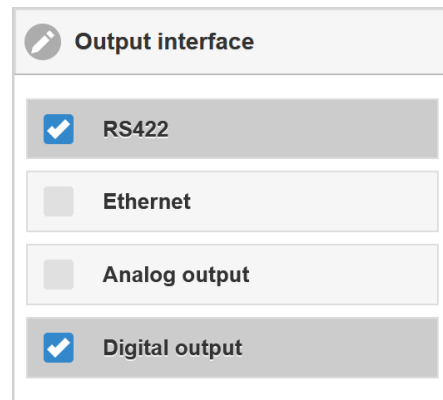

Fig. 70 Selecting the required interfaces for data output

Grey shaded fields require a selection.

Value Fields with dark border require entry of a value.

7.5.7 Ethernet Settings

Ethernet	IP settings of the device	<i>Static IP address / DHCP</i>	<i>Values for IP address / gateway / subnet mask. Only for static IP address</i>
	Ethernet measured value transfer settings	<i>Server TCP Client TCP Client UDP</i>	<i>Value for the port</i>

When using a static IP address it is necessary to enter the values for the IP address, Gateway and Subnet mask; this is not required when DHCP is used.

The controller is factory set to the static IP address 169.254.168.150

The controller transmits the Ethernet packets at a transmission rate of 10 MBit/s or 100 MBit/s. The transfer rate is selected automatically depending on the connected network or PC.

All output values and additional information to be transferred, saved at a certain time, are consolidated to a measured value frame. Multiple measured value frames are combined into one measurement block. A header is added to the start of each measured value frame.

During transfer of measured value data, the controller sends each measured value (measured value frame) to its connected counterpart after the connection has been successfully set up.

No explicit request is necessary for this.

If any changes are made to the transmitted data or the frame rate, a new header will be sent automatically. Thickness values are transmitted as 32 bit signed integer value with 10 pm resolution.

Example: Output of measurement values $7835 = 7,853 * 10^{-5}$ mm.

This measured value frame can also consist of several Ethernet packets, depending on the size of the FFT signal.

7.6 System settings

7.6.1 Unit Website

Specifies the unit for display on the web page and for all input parameters related to units. You can select between mm and inches.

i Data output via Ethernet/analog output is not affected by this setting.

The web interface supports the unit 10^1 pm when displaying measuring results.

7.6.2 Language Support

You can choose German or English in the web interface. You can change the language in the menu bar.

The ASCII support is in English.

7.6.3 Key Lock

The key lock function avoids unauthorized or unintended button operation. The key lock of the `Multifunction` button can be set individually.

Key Lock	<i>Automatic</i>	Value (1 ... 60 min)	<i>Keylock starts after expiry of a defined time.</i>
	<i>Active</i>		<i>Keylock starts immediately.</i>
	<i>Inactive</i>		<i>No key lock</i>

The `Multifunction` button is delivered with a key lock function which is automatically activated 5 minutes after the controller has been switched on.

7.6.4 Load and Safe

You can save device settings in the controller or activate saved settings. Detailed information is available in the Load/Save Settings section, see [Chap. 6.9](#).

7.6.5 Import, Export

A parameter set includes the current measurement and device settings (setups) and the initial setup during booting of the controller. The `Import` & `Export` menu enables easy exchange of parameter sets with a PC/notebook.

Exchange of parameter sets with PC/notebook, possibilities	
Storing parameter set on PC	Loading parameter set from PC
<p>Menu <code>Import</code> & <code>Export</code></p> <p>➡ Click on the button <code>Create a parameter set</code> with the left mouse button.</p> <p>The dialog <code>Choose export data</code> opens.</p> <p>➡ Compose a parameter set by selecting/deselecting the checkboxes.</p> <p>➡ Click on the button <code>Transmit file</code>.</p> <p>A Windows dialog for data transfer opens.</p> <p>➡ Acknowledge the dialog with <code>OK</code>.</p> <p>The operating system files the parameter set in <code>Download</code>. The file name for the adjacent example is <code><...\Downloads\IMC5420_BASICSETTINGS_MEASSETTINGS_... .JSON></code></p>	<p>Menu <code>Import</code> & <code>Export</code></p> <p>➡ Click on the button <code>Search</code>.</p> <p>A Windows dialog for file selections opens.</p> <p>➡ Choose the desired file and click on the button <code>Open</code>.</p> <p>The dialog <code>Choose import data</code> opens.</p> <p>➡ Determine the operations to be performed by selecting/deselecting the checkboxes.</p> <p>➡ Click on the button <code>Transmit parameter set</code>.</p>
<p>Choose export data</p> <p>Settings</p> <p><input checked="" type="checkbox"/> F2014</p> <p><input checked="" type="checkbox"/> T2_M</p> <p>Materialtable</p> <p><input checked="" type="checkbox"/> MATERIALTABLE</p> <p>Initial Setup at booting</p> <p><input checked="" type="checkbox"/> T2_M</p> <p>General Sensor settings</p> <p><input checked="" type="checkbox"/> General Sensor settings</p> <p>Transmit file</p>	

In order to avoid that an already existing setup is overwritten unintentionally during import, an automatic security request is carried out (see adjacent figure).

Options during import

- Overwrite existing setups (with the same name)
- Apply settings of the imported initial setup

7.6.6 Access Authorization

Assigning passwords prevents unauthorized changes to the controller settings. The password protection is not activated in the delivery condition. The controller works on the `Professional` level. After the controller has been configured, you should enable password protection. The standard password for the `Professional` level is "000".

i A software update will not change the default password or a user-defined password. The `Professional` password is independent from Setup and is thus not loaded or stored with Setup.

The following functions are accessible for the user:

	User	Professional
Password required	no	yes
View settings	yes	yes
Change settings, change password	no	yes
View readings, FFT signals	yes	yes
Scale graphs	yes	yes
Multifunction button	no	yes
Restore factory settings	no	yes

Fig. 71 Permissions within the user hierarchy

Enter the default password "000" or a user-defined password in the `Password` field and click on `Login` to confirm.

Fig. 72 Changing to professional level

The user management enables to define a user-specific password in `Professional` mode.

Password	<i>Value</i>	<i>All passwords are case-sensitive. Numbers are allowed. Special characters are not permitted.</i>
User level when restarting	<i>User / Professional</i>	<i>Defines the user level that is enabled when the sensor starts the next time. MICRO-EPSILON recommends selecting Professional level here.</i>

 Grey shaded fields require a selection.

 *Value* Fields with dark border require entry of a value.

7.6.7 Reset Controller

This menu section enables to reset the individual settings to factory settings. This menu requires the Expert user level.

<i>Measurement settings</i>	<i>Resets the preset to Standard thick glass and all parameters (except for interface settings) to factory setting.</i>
<i>Device settings</i>	<i>Reset the Ethernet interface to factory settings.</i>
<i>Reset of the material table</i>	<i>Reset the material table to factory settings.</i>
<i>Reset all</i>	<i>Reset the device and measurement settings to factory settings.</i>
<i>Reboot controller</i>	<i>Starts the controller with the last saved settings</i>

7.6.8 Light Source

You can turn on or off the SLED (light source) and the pilot laser.

7.6.9 Material Table

This menu item enables you to compare the settings of the listed materials or to add a new material.

7.6.10 Switching between Ethernet and EtherCAT

This setting defines the connection log when the controller is started. You can also switch between Ethernet and EtherCAT via an ASCII command or EtherCAT object.

Save the current settings before switching to EtherCAT.

➤ Switch to the Settings > System settings menu and select EtherCAT as the interface.

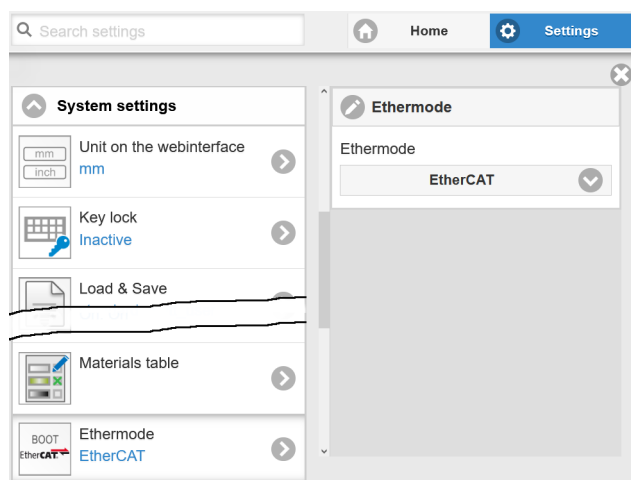

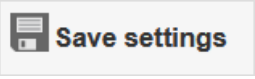
➤ Click on the  **Save settings** button.

The switch becomes active only after restarting the controller. The web interface is not available in EtherCAT mode.

The RS422 interface for sending an ASCII command is available both in Ethernet mode and in EtherCAT mode.

8. Thickness Measurement

8.1 Requirements

In order to measure the thickness of a transparent target from one side, the controller evaluates two signals reflected by the surface. The controller uses both signals to calculate the distances from the targets and thus the thickness can be derived.

➤ Align the sensor vertically to the target object. Ensure that the target is located near the working distance.

i The light beam must meet the target surface at a right angle to avoid inaccurate measurements.

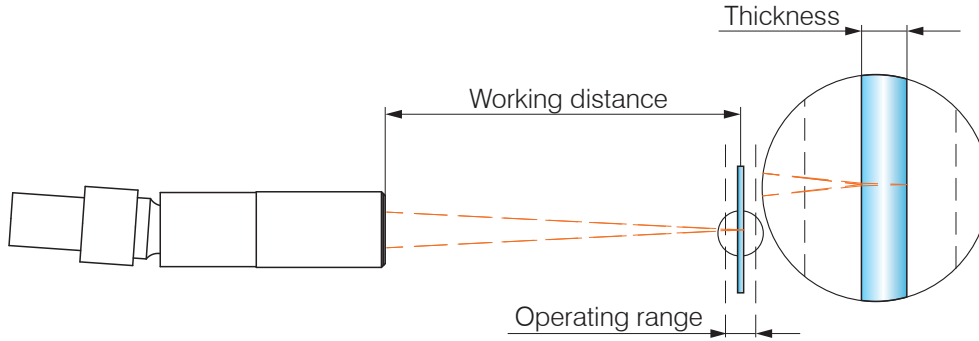

Fig. 73 Single-sided thickness measurement for a transparent object

Minimum target thickness ¹	50 μm / group index
Maximum target thickness ¹	1.05 mm / group index
Minimum air thickness ²	200 μm
Maximum air thickness ²	4 mm

1) Measuring range with $n=3.82$ (silicon, undoped)

2) For air gap measurement between two glass plates ($n \sim 1$) the measuring range is 0.2 ... 4.0 mm. The measurement object must be within the working distance

8.2 Sensor Selection

Thickness measurement is only possible with IMP-THxx model series sensors.

➤ Change to the `Settings > Sensor` menu.

8.3 Material Selection

Specifying the material is essential for calculating a correct thickness value.

➤ Switch to the `Settings > Data recording > Material selection` menu.

➤ Select the target material in the field `Layer 1`.

8.4 FFT Signal

If a target surface is outside the measuring range, the controller provides no measuring value. This might also happen, if one signal is below the detection threshold. Highly doped wafers typically have low peaks; therefore choose the detection threshold with care.

When measuring the thickness of a transparent material, two boundary areas are active. However, only one peak is visible in the FFT signal.

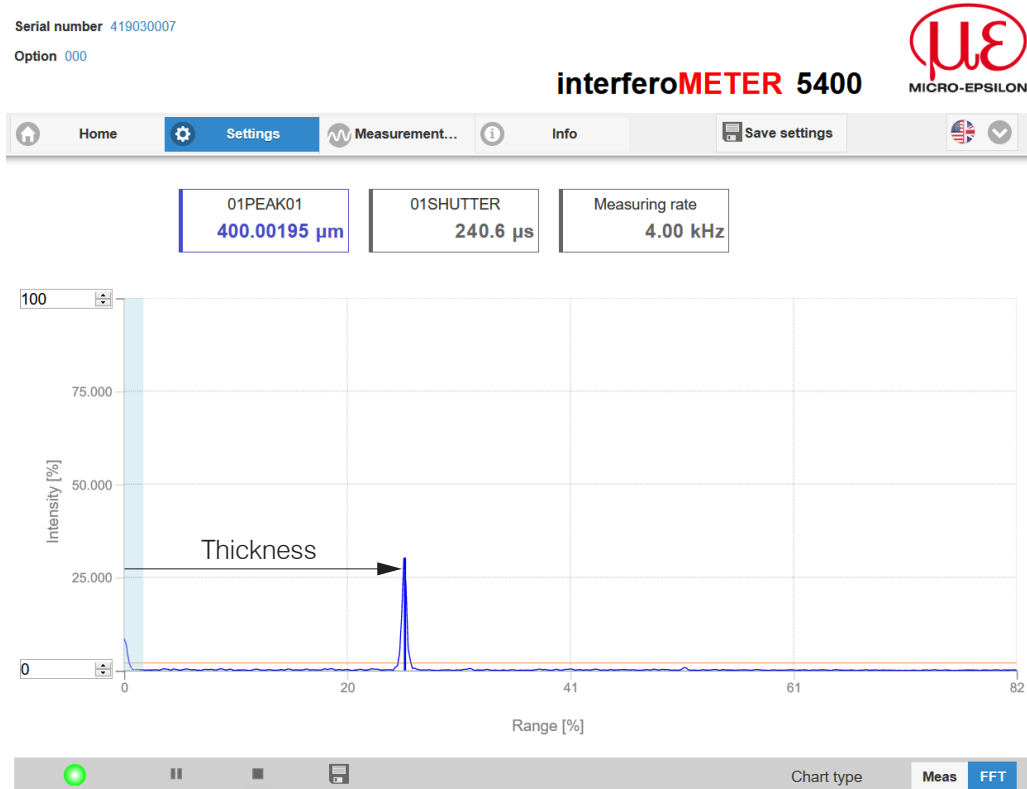

Fig. 74 FFT signal web page (thickness measurement)

8.4.1 Measurement Chart

➡ Change to the Measurement chart and choose the Meas type.

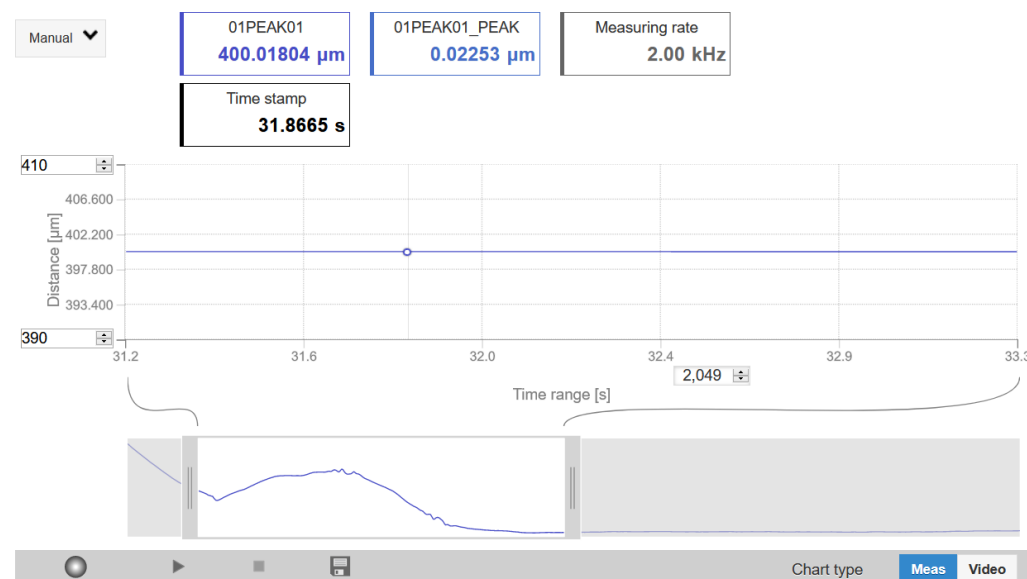

Fig. 75 Offline analysis of measured thickness results based on a one-sided thickness measurement

The thickness is displayed graphically and numerically on the web page.

9. Disclaimer

All components of the device have been checked and tested for functionality in the factory. However, should any defects occur despite careful quality control, these shall be reported immediately to MICRO-EPSILON or to your distributor / retailer.

MICRO-EPSILON undertakes no liability whatsoever for damage, loss or costs caused by or related in any way to the product, in particular consequential damage, e.g., due to

- non-observance of these instructions/this manual,
- improper use or improper handling (in particular due to improper installation, commissioning, operation and maintenance) of the product,
- repairs or modifications by third parties,
- the use of force or other handling by unqualified persons.

This limitation of liability also applies to defects resulting from normal wear and tear (e.g., to wearing parts) and in the event of non-compliance with the specified maintenance intervals (if applicable).

MICRO-EPSILON is exclusively responsible for repairs. It is not permitted to make unauthorized structural and / or technical modifications or alterations to the product. In the interest of further development, MICRO-EPSILON reserves the right to modify the design.

In addition, the General Terms of Business of MICRO-EPSILON shall apply, which can be accessed under Legal details | Micro-Epsilon <https://www.micro-epsilon.com/impressum/>.

10. Service, Repair

If the sensor, controller or sensor cable is defective:

- If possible, save the current sensor settings in a parameter set, see [Chap. 6.6](#), to reload them into the controller after the repair.
- Please send us the affected parts for repair or exchange.

If the cause of a fault cannot be clearly identified, please send the entire measuring system to:

MICRO-EPSILON Messtechnik GmbH & Co. KG
Koenigbacher Str. 15
94496 Ortenburg / Germany

Tel. +49 (0) 8542 / 168-0
Fax +49 (0) 8542 / 168-90
info@micro-epsilon.com
www.micro-epsilon.com

11. Decommissioning, Disposal

In order to avoid the release of environmentally harmful substances and to ensure the reuse of valuable raw materials, we draw your attention to the following regulations and obligations:

- Remove all cables from the sensor and/or controller.
- Dispose of the sensor and/or the controller, its components and accessories, as well as the packaging materials in compliance with the applicable country-specific waste treatment and disposal regulations of the region of use.
- You are obliged to comply with all relevant national laws and regulations.

For Germany / the EU, the following (disposal) instructions apply in particular:

- Waste equipment marked with a crossed garbage can must not be disposed of with normal industrial waste (e.g. residual waste can or the yellow recycling bin) and must be disposed of separately. This avoids hazards to the environment due to incorrect disposal and ensures proper recycling of the old appliances.
- A list of national laws and contacts in the EU member states can be found at https://ec.europa.eu/environment/topics/waste-and-recycling/waste-electrical-and-electronic-equipment-weee_en. Here you can inform yourself about the respective national collection and return points.
- Old devices can also be returned for disposal to MICRO-EPSILON at the address given in the imprint at <https://www.micro-epsilon.de/impressum/>.
- We would like to point out that you are responsible for deleting the measurement-specific and personal data on the old devices to be disposed of.
- Under the registration number WEEE-Reg.-Nr. DE28605721, we are registered at the foundation Elektro-Altgeräte Register, Nordostpark 72, 90411 Nuremberg, as a manufacturer of electrical and/or electronic equipment.



Appendix

A 1 Accessories, Services

Mounting adapter

MA5400-10 Mounting adapter for IMP-TH24 sensors

Sensor cable (optical fiber)

C5421-x Standard E2000/APC (controller) and FC/APC plug (sensor), optical fiber length $x = 1\text{ m}, 2\text{ m}, 3\text{ m}, 5\text{ m}$
other lengths available on request up to 20 m

C5421IP67-x Standard cable for IMC5420IP67-TH24 controller, optical fiber length $x = 0.5\text{ m}, 1\text{ m}, 2\text{ m}$

Vacuum feed through

C5405/VAC/1/CF16 Vacuum feed through with CF flange

C5405/VAC/1/KF16 Vacuum feed through with CK flange

Other accessories

SC2471-3/IF2008ETH Connector cable between IMC5420 and IF2008/ETH, length 3 m

SC2471-x/IF2008 Connector cable between IMC5420 and IF2008/PCIE or IF2004/USB, length 3 m or 10 m

SC2471-x/RS422/OE Interface cable for interface IF2035, length 3 m or 10 m

EC2471-3/OE Encoder cable, length 3 m, one-sided open ends

PC5420IP67-x Power supply cable for IMC5420IP67, length 1.5 m or 3 m

SC5420IP67-IE-x-RJ45 Patch cable with 5-pin male M12 connector and RJ45 connector, length 3 m

SC5420IP67-OE-x Interface cable for interface IF2035 PROFINET or EtherNet/IP, IF2001/USB, length 3 m or 10 m, one-sided open ends

IF2001/USB Converter RS422 to USB, type IF2001/USB, useable for cable SC2471-x/RS422/OE, inclusive driver,
connections: 1 × female connector 10-pin (cable clamp) type Würth 691361100010,
1x female connector 6-pin (cable clamp) type Würth 691361100006

IF2004/USB 4-channel RS422/USB converter for one to four controllers with RS422 interface, additionally with trigger input, suitable for SC2471-x/IF2008 cable, data output via USB interface, a 24 VDC/2 A power supply is required for operation (not included)

IF2008/ETH 8-channel RS422 to Ethernet converter with industrial M12 plug/socket for connecting up to 8 controllers with RS422 interface; additionally 4 programmable switching inputs and outputs that can be operated via TTL and HTL logic, suitable for SC2471-x/IF2008ETH cable, permissible ambient temperature +5 to +50 °C; protection class IP65

IF2008/PCIE Interface card IF2008/PCIE to capture four digital sensor signals synchronously and two encoders. In conjunction with IF2008E a total of six digital signals, two encoders, two analog signals and eight I/O signals can be captured synchronously

IF2035-PROFINET Interface module for PROFINET connection of Micro-Epsilon sensors to RS422/RS485 interface, suitable for SC2471-x/RS422/OE cable, 1-channel system with top-hat rail housing, incl. GSDML file for software integration into the PLC, certified according to PNIO V2.33

IF2035-EIP Interface module for Ethernet/IP connection of Micro-Epsilon sensors to RS422/RS485 interface, suitable for SC2471-x/RS422/OE cable, 1-channel system with top-hat rail housing, incl. EDS file for software integration into the PLC, certified according to Ethernet/IP CT16

EK1122 2-port EtherCAT junction

PS2020	Power supply unit for DIN rail mounting, input 230 VAC, output 24 VDC/2.5 A
PC5420-x	Power supply cable for IMS5420IP67-TH24

A 2 Factory Settings

User group: Professional, password: "000"
Data output: Web interface
RS422: 115.2 KBaud
Trigger mode: no trigger
Language: de
Synchronization: no synchronization
Key function 1: Pilot laser on/off

Measured value averaging: moving, 4 values
Error handling: error output
Ethernet: static IP, 169.254.168.150
Measuring rate: 6 kHz
Unit web interface: mm
Data reduction: no
Key function 2: inactive

You find a view on all parameters in the [Info > System overview](#) menu.

A 3 ASCII Communication with Controller

A 3.1 General

The ASCII commands can be sent to the controller via the RS422 interface or Ethernet (Port 23). All commands, inputs and error messages are in English. A command always consists of the command name and zero or more parameters, which are separated by spaces and are completed with LF. If spaces are used in parameters, the parameters must be placed in quotation marks, e.g. "password with spaces".

Example: Switch on the output via Ethernet

```
OUTPUT ETHERNET ↵
```

Advice: ↵ must include LF, but may also be CR LF.

Declaration: LF Line feed (line feed, hex 0A)

CR Carriage return (carriage return, hex 0D)

↵ Enter (depending on the system hex 0A or hex 0D0A)

The currently set parameter value is returned, if a command is activated without parameters.

The output format is:

```
<Command name> <Parameter1> [<Parameter2> [...]]
```

The reply can be used again as command for the parameter setting without changes. In this case, optional parameters are returned only where necessary.

After processing a command, the system always returns a line break and a command prompt. In the event of an error, an error message starting with "Exxx" will appear before the prompt, where xxx represents a unique error number. In addition, the system may display a warning ("Wxxx") instead of an error message.

Warnings are structured analogously to error messages. Warnings do not prevent commands from being executed.

A 3.2 Commands Overview

Group	Chapter	Command	Short description	IMC5420 IMC5420MP	IMC5420IP67
General					
	Chap. A 3.3.1.1	HELP	Help	•	•
	Chap. A 3.3.1.2	GETINFO	Controller Information	•	•
	Chap. A 3.3.1.3	ECHO	Reply Type	•	•
	Chap. A 3.3.1.4	PRINT	Parameter Overview	•	•
	Chap. A 3.3.1.5	SYNC	Synchronization	•	•
	Chap. A 3.3.1.6	TERMINATION	Termination Resistor	•	•
	Chap. A 3.3.1.7	RESET	Booting the Controller	•	•
	Chap. A 3.3.1.8	RESETCNT	Reset Counter	•	•
User Level					
	Chap. A 3.3.2.1	LOGIN	Changing the User Level	•	•
	Chap. A 3.3.2.2	LOGOUT	Changing to User Level	•	•
	Chap. A 3.3.2.3	GETUSERLEVEL	Querying the User Level	•	•
	Chap. A 3.3.2.4	STDUSER	Defining a Standard User	•	•
	Chap. A 3.3.2.5	PASSWD	Changing the Password	•	•
Sensor					
	Chap. A 3.3.3.1	SENSORTABLE	Displays Available Sensors, Calibration Tables	•	•
	Chap. A 3.3.3.2	SENSORHEAD	Sensor Selection	•	•
	Chap. A 3.3.3.3	SENSORINFO	Sensor Information	•	•
	Chap. A 3.3.3.4	PILOTLASER	Pilot laser On/Off	•	•
	Chap. A 3.3.3.5	SLED	SLED On/Off	•	•

Triggering				IMC5420 IMC5420MP	IMC5420IP67
	Chap. A 3.3.4.1	TRIGGERSOURCE	Select Trigger Source	•	
	Chap. A 3.3.4.2	TRIGGERAT	Effect of the Trigger Input	•	
	Chap. A 3.3.4.3	TRIGGERMODE	Trigger Type	•	
	Chap. A 3.3.4.4	TRIGGERLEVEL	Active Level Trigger Input	•	
	Chap. A 3.3.4.5	TRIGGERSW	Create a software trigger pulse	•	•
	Chap. A 3.3.4.6	TRIGGERCOUNT	Number of Output Measurement Values	•	•
	Chap. A 3.3.4.7	TRIGINLEVEL	Trigger Level TrigIn (TTL / HTL)	•	
	Chap. A 3.3.4.8	TRIGGERENCMAX	Maximum Encoder Triggering	•	
	Chap. A 3.3.4.9	TRIGGERENCMIN	Minimum Encoder Triggering	•	
	Chap. A 3.3.4.10	TRIGGERENCSTEPSIZE	Step Size Encoder Triggering	•	
Encoder					
	Chap. A 3.3.5.1	ENCINTERPOLn	Setting Interpolation Depth	•	
	Chap. A 3.3.5.2	ENCREFn	Setting the reference track	•	
	Chap. A 3.3.5.3	ENCVALUEn	Setting Encoder Value	•	
	Chap. A 3.3.5.4	ENCSET	Setting Encoder Value	•	
	Chap. A 3.3.5.5	ENCRESET	Reset Encoder Value	•	
	Chap. A 3.3.5.6	ENCMAXn	Setting Maximum Encoder Value	•	
	Chap. A 3.3.5.7	ENCODER3	Encoder3 On/Off	•	
Interfaces					
	Chap. A 3.3.6.1	IPCONFIG	Ethernet Settings	•	•
	Chap. A 3.3.6.2	MEASTRANSFER	Setting the Measured Value Server	•	•
	Chap. A 3.3.6.3	BAUDRATE	RS422 Setting	•	•
	Chap. A 3.3.6.4	ETHERMODE	Switching between Ethernet and EtherCAT	•	
	Chap. A 3.3.6.5	MEASCNT_ETH	Measurements per frame	•	•
	Chap. A 3.3.6.6	TCPKEEPALIVE	TCP On/Off	•	•
Parameter Management, Load / Save Settings					
	Chap. A 3.3.7.1	BASICSETTINGS	Load Connection Settings	•	•
	Chap. A 3.3.7.2	CHANGESETTINGS	Show Changed Parameters	•	•
	Chap. A 3.3.7.3	EXPORT	Export of Parameter Sets	•	•
	Chap. A 3.3.7.4	IMPORT	Import of Parameter Sets	•	•
	Chap. A 3.3.7.5	SETDEFAULT	Reset to Factory Settings	•	•
	Chap. A 3.3.7.6	MEASSETTINGS	Edit Measurement Settings	•	•
Measurement					
	Chap. A 3.3.8.1	MEASRATE	Measuring Rate	•	•
	Chap. A 3.3.8.2	ROI	Masking the Evaluation Range	•	•
	Chap. A 3.3.8.3	MIN_THRESHOLD	Peak Detection Threshold	•	•
Material Data Base					
	Chap. A 3.3.9.1	MATERIALTABLE	Material Table	•	•
	Chap. A 3.3.9.2	MATERIAL	Select Material	•	•
	Chap. A 3.3.9.3	MATERIALINFO	Display Material Properties	•	•
	Chap. A 3.3.9.4	MATERIALEDIT	Edit Material Table	•	•
	Chap. A 3.3.9.5	MATERIALADD	Add Material	•	•
	Chap. A 3.3.9.6	MATERIALMP	Determine Material Composition of Target	•	•
	Chap. A 3.3.9.7	MATERIAL_INFRONT	Determine Material or Medium in Front of Target	•	•
	Chap. A 3.3.9.8	MATERIALDELETE	Delete a Material	•	•
	Chap. A 3.3.9.9	PEAKCOUNT	Number of Peaks	•	•

Measurement Value Processing				IMC5420 IMC5420MP	IMC5420IP67
	Chap. A 3.3.10.1	META_STATISTICSIGNAL	List of Possible Signal for the Statistics to be Selected	•	•
	Chap. A 3.3.10.2	STATISTICSIGNAL	Selection of a Signal for the Statistics	•	•
	Chap. A 3.3.10.3	META_STATISTIC	List of Possible Signals for the Statistics	•	•
	Chap. A 3.3.10.4	STATISTIC	Selection of a Signal for the Statistics	•	•
	Chap. A 3.3.10.6	META_MASTERSIGNAL	List of Signals which can be Parameterized	•	•
	Chap. A 3.3.10.7	MASTERSIGNAL	Master Signal Parameterization	•	
	Chap. A 3.3.10.8	META_MASTER	List of Possible Signals for Mastering	•	
	Chap. A 3.3.10.9	MASTER	Activate Mastering	•	
	Chap. A 3.3.10.11	COMP	Channel Selection	•	•
	Chap. A 3.3.10.12	META_COMP	List of Possible Calculation Signals	•	•
Data Output					
	Chap. A 3.3.11.1	OUTPUT	Selection of Digital Output	•	•
	Chap. A 3.3.11.2	OUTREDUCEDEVICE	Data Output Rate	•	•
	Chap. A 3.3.11.3	OUTREDUCECOUNT	Reduction Counter	•	•
	Chap. A 3.3.11.4	OUTHOLD	Error Processing	•	•
Select Measurement Values to be Output via Interfaces					
	Chap. A 3.3.12.2	OUT_ETH	Data selection for Ethernet	•	•
	Chap. A 3.3.12.3	META_OUT_ETH	List of Possible Ethernet Signals	•	•
	Chap. A 3.3.12.4	GETOUTINFO_ETH	List of Selected Signals, Transfer Sequence via Ethernet	•	•
Switching Outputs					
	Chap. A 3.3.13.1	ERROROUTn	Error Switching Output	•	
	Chap. A 3.3.13.2	ERRORLIMITSIGNALn	Setting the Signal to be Evaluated	•	
	Chap. A 3.3.13.3	META_ERRORLIMITSIGNAL	List of Possible Signals for Error Output	•	
	Chap. A 3.3.13.4	ERRORLIMITCOMPARETO	Setting Limit Values	•	
	Chap. A 3.3.13.5	ERRORLIMITVALUESn	Setting Value	•	
	Chap. A 3.3.13.6	ERRORLEVELOUTn	Switching Behavior of Error Outputs	•	
Analog Output					
	Chap. A 3.3.14.1	ANALOGOUT	Data Selection for Analog Output	•	
	Chap. A 3.3.14.2	META_ANALOGOUT	List of Possible Signals Analog Output	•	
	Chap. A 3.3.14.3	ANALOGRANGE	Setting Current/Voltage Range of Digital-Analog Converter (DAC)	•	
	Chap. A 3.3.14.4	ANALOGSCALEMODE	Setting the Scaling of DAC	•	
	Chap. A 3.3.14.5	ANALOGSCALERANGE	Setting the Scaling Range	•	
Key Functions					
	Chap. A 3.3.15.1	KEYFUNC	Activating Multifunction Button	•	
	Chap. A 3.3.15.2	KEYMASTERSIGNALSELECT	Signal selection	•	
	Chap. A 3.3.15.3	KEYLOCK	Key lock configuration	•	

A 3.3 General Commands

A 3.3.1 General

A 3.3.1.1 Help

```
HELP [HELP | <Command>]
```

Help is displayed for a command. If no command is specified, general help information is displayed.

A 3.3.1.2 Controller Information

```
GETINFO
```

Controller data are queried. Output as per example below:

```
->GETINFO
Name:          IMC5420
Serial:        12345678
Option:        000
Article:       12345678
MAC-Address:   00-0C-12-01-62-03
Version:       001.036.014
Hardware-rev:  02
Boot-version:  002.003
BuildID:       4
Timestamp:     20191219_103316
```

- Name: Name of the controller model / controller series
- Serial: Controller serial number
- Option: Controller option number
- Article: Controller article number
- MAC Address: Network adapter address
- Version: Version of the booted software
- Hardware-rev: Used hardware revision
- Boot-version: Version of the boot loader
- BuildID: Identification number of the generated software

A 3.3.1.3 Reply type

```
ECHO [ON | OFF]
```

The reply type describes the structure of a command reply.

- ECHO ON: Displays command name and command reply or an error message.
- ECHO OFF: Only displays command reply or an error message.

A 3.3.1.4 Parameter Overview

```
PRINT
```

This command outputs a list of all setting parameters and its values.

A 3.3.1.5 Synchronization

SYNC [NONE | MASTER | SLAVE_SYNTRIG | SLAVE_TRIGIN]

Setting the type of synchronization:

- NONE: No synchronization
- MASTER: With this setting, the controller is the master, i.e., it outputs synchronization impulses at the Sync/Trig output
- SLAVE_SYNTRIG: With this setting, the controller is the slave and waits for synchronization impulses, e.g., from another controller or similar impulse source, at the Sync/Trig input.
- SLAVE_TRIGIN: With this setting, the controller is the slave. The synchronization signal is received via the Trig interface. You can select HTL or TTL level.

Input	Characteristic
Sync / Trig	Differential
TrigIn	TTL / HTL

Sync/Trig may be an input or output, so you need to ensure that one of the controllers is defined as a master and the other one as a slave.

The TrigIn input is also used as trigger input for flank and level triggering.

A 3.3.1.6 Termination Resistor at Sync/Trig Input

TERMINATION [ON | OFF]

Switching a terminating resistor into the synchronization line.

The terminating resistor at the Sync/Trig synchronization input is switched on or off to avoid reflections.

- OFF: No terminating resistor
- ON: With terminating resistor

A 3.3.1.7 Booting the Controller

RESET

The controller restarts.

A 3.3.1.8 Reset Counter

RESETCNT [TIMESTAMP] [MEASCNT]

The counter is reset after the selected trigger edge has arrived.

- TIMESTAMP: Resets the time stamp
- MEASCNT: Resets the measured value counter

A 3.3.2 User Level

A 3.3.2.1 Changing the User Level

```
LOGIN <Password>
```

Enter the password to switch to Professional level.

The following user levels exist:

- USER: Read-only access to all elements + use of the web diagrams
- PROFESSIONAL: Read/write access to all elements

A 3.3.2.2 Changing to User Level

```
LOGOUT
```

Sets the user level to USER.

A 3.3.2.3 Querying the User Level

```
GETUSERLEVEL
```

Request the current user level.

For possible responses, see [Chap. A 3.3.2.1](#), „Changing the user level“.

A 3.3.2.4 Defining a Standard User

```
STDUSER [USER | PROFESSIONAL]
```

Sets the standard user, who is logged in after system start.

A 3.3.2.5 Changing the Password

```
PASSWD <Old Password> <New Password> <New Password>
```

Changes the password for the PROFESSIONAL level. The default (preset) password “000”.

The old password must be entered once, and the new password twice.

If the new pass-words do not match, an error message is displayed. Passwords are case sensitive. A password may only contain letters (A to Z) and numbers, but no special characters and no letters with accents or umlauts. The maximum length is 31 characters.

A 3.3.3 Sensor

A 3.3.3.1 Info about Calibration Tables

SENSORTABLE

```
->SENSORTABLE
Channel, Position, Sensor name, Measurement range, Serial number
1, 1 IMP-TH24 2.100 mm, 12345678
->
```

All available (learned) sensors are displayed.

A 3.3.3.2 Sensor Number

SENSORHEAD [<number>]

Selects the current sensor from its position in the sensor table.

A 3.3.3.3 Sensor Information

SENSORINFO

Output of information about the active sensor (name, measuring range and serial number).

```
->SENSORINFO
Position: 0
Sensor name: IMP-TH24
Measurement range: 2.100 mm
Serial number: 12345678

Sensor Type: Thickness
->
```

A 3.3.3.4 Pilot Laser

PILOTLASER [ON | OFF]

Indicates the current status of the pilot laser, or switches the pilot laser on or off.

A 3.3.3.5 SLED

SLED [ON | OFF]

Indicates the current status of the SLED, or switches the SLED on or off.

A 3.3.4 Triggering

A 3.3.4.1 Select Trigger Source

TRIGGERSOURCE [NONE | SYNCTRIG | TRIGIN | SOFTWARE | ENCODER1 | ENCODER2 | ENCODER3]

The trigger source triggers the triggering process.

- NONE: No trigger source
- SYNCTRIG: Use Sync/Trig input
- TRIGIN: Use TrigIn input
- SOFTWARE: Triggering is caused by the TRIGGERSW command.
- ENCODER1/ENCODER2: Triggered by encoder1 or 2.
- ENCODER3: Triggered by encoder3 (ENCODER3 must be switched on)

A 3.3.4.2 Output of Triggered Values, With/Without Averaging

TRIGGERAT [INPUT | OUTPUT]

- INPUT: Triggering the measured value recording. When calculating the mean, measured values immediately before the trigger event are not included; instead older measured values are used, which were the output in previous trigger events.
- OUTPUT: Triggering the measurement value output. When calculating the mean, measured values immediately before the trigger event are used.

Triggering of measured value recording is enabled as a factory default setting.

A 3.3.4.3 Trigger Type

TRIGGERMODE [EDGE | PULSE]

Defines the trigger type. Only enabled if TRIGGERSOURCE has been set to SYNC or TRIGIN.

- PULSE: Level triggering
- EDGE: Edge triggering

A 3.3.4.4 Active Level Trigger Input

TRIGGERLEVEL [HIGH | LOW]

- HIGH: Edge triggering: Rising edge, level triggering: High-active
- LOW: Edge triggering: Falling edge, level triggering: Low-active

A 3.3.4.5 Software Trigger Pulse

TRIGGERSW

Creates a software trigger pulse, if Software is selected as trigger source. With low measuring rates < 2.4 kHz and FFT signal selected, unreliable trigger information may occur.

A 3.3.4.6 Number of Output Measurement Values

TRIGGERCOUNT [NONE | INFINITE | <n>]

- NONE: Stop triggering
- <n>: Number of measurement values which are displayed after a trigger impulse when edge triggering or software triggering.
- Infinite: Start infinite output of measurement values after a trigger impulse when edge triggering or software triggering.

A 3.3.4.7 Trigger Level TrigIn

TRIGINLEVEL [TTL | HTL]

The level selection only applies for the TrigIn input. The Sync/Trig input expects a differential signal.

- TTL: Input expects TTL signal.
- HTL: Input expects HTL signal.

A 3.3.4.8 Maximum Encoder Triggering

```
TRIGGERENCMAX [<maximum_value>]
```

Set maximum encoder value for triggering.
The value can be set between 0 and $2^{32}-1$.

A 3.3.4.9 Minimum Encoder Triggering

```
TRIGGERENCMIN [<minimum_value>]
```

Set minimum encoder value for triggering.
The value can be set between 0 and $2^{32}-1$.

A 3.3.4.10 Step Size Encoder Triggering

```
TRIGGERENCSTEPSIZE [<value_of_step_size>]
```

Set step size between triggering events.

If the value is set to 0 and the encoder value is between minimum and maximum, all values are output. The value can be set between 0 and $2^{32}-1$.

A 3.3.4.11 Example

An encoder should cause triggering in the controller. For this purpose, the commands below were sent to the encoder:

```
TRIGGERENCMIN 5
```

```
TRIGGERENCMAX 35
```

```
TRIGGERSTEPSIZE 10
```

Result: The encoder starts triggering at counters 10, 20 and 30.

A 3.3.5 Encoder

A 3.3.5.1 Encoder Interpolation Depth

```
ENCINTERPOL1 [1 | 2 | 4]
```

```
ENCINTERPOL2 [1 | 2 | 4]
```

```
ENCINTERPOL3 [1 | 2 | 4]
```

Set the interpolation depth of each encoder input.

A 3.3.5.2 Effect of the Reference Track

```
ENCREF1 [NONE | ONE | EVER]
```

```
ENCREF2 [NONE | ONE | EVER]
```

Setting the effect of encoder reference track

- NONE: Reference mark of the encoder has no effect.
- ONE: Unique setting (the encoder value is taken over at first reaching of reference marker position)
- EVER: Setting at all marker positions (the encoder value is taken over at first reaching of reference marker position).

A 3.3.5.3 Encoder Value

```
ENCVALUE1 [<Encoderwert>]
```

```
ENCVALUE2 [<Encoderwert>]
```

```
ENCVALUE3 [<Encoderwert>]
```

Indicates, on which value the applicable encoder is to be set when reaching a reference marker position (or per software).

The encoder value can be set between 0 and $2^{32}-1$.

When setting the ENCVALUE, the algorithm for detecting the first reference marker position, is reset automatically.

A 3.3.5.4 Setting Encoder Value per Software

```
ENCSET 1 | 2 | 3
```

Setting the encoder value in the specified encoder per software (only possible with ENCREF NONE, otherwise the command returns immediately without an error message).

A 3.3.5.5 Reset the Detection of the First Marker Position

```
ENCRESET 1 | 2
```

Reset the detection of the first reference marker position (only possible with ENCREF NONE, otherwise the command returns immediately without an error message).

A 3.3.5.6 Maximum Encoder Value

```
ENCMAX1 [<Encoder value>]
```

```
ENCMAX2 [<Encoder value>]
```

Specifies the maximum value of the encoder, after which the encoder returns to 0. Can be used e.g. for rotary encoder without reference track.

The encoder value can be set between 0 and $2^{32}-1$.

A 3.3.5.7 Encoder3 On/Off

```
ENCODER3 [ON | OFF]
```

If Encoder3 is switched on, ENCREF1 and ENCREF2 are set to NONE.

A 3.3.6 Interfaces

A 3.3.6.1 Ethernet IP Settings

```
IPCONFIG DHCP | (STATIC [<IPAddress> [<Netmask> [<Gateway>]]])
```

Set Ethernet interface.

- **DHCP**: IP address and gateway are automatically requested by DHCP. System looks for a LinkLocal address after approx.. 2 minutes if no DHCP server is available.
- **STATIC**: Set IP address, net mask and gateway in format xxx.xxx.xxx.xxx.

Values stay the same if no IP address, net mask, and/or gateway is typed in.

A 3.3.6.2 Setting for Ethernet Transmission of Measured Values

```
MEASTRANSFER [NONE | SERVER/TCP [<PORT>] | (CLIENT/TCP | CLIENT/UDP [<IP> [<Port>]])]
```

The controller can be operated as a server as well as a client for measurement output via Ethernet.

- **NONE**: No measurement transmission via Ethernet.
- **SERVER/TCP**: Controller provides a server for the typed in port, under which the measured values can be sent. This is only possible via TCP/IP.
- **CLIENT/TCP**: Controller sends measured values via TCP/IP connection oriented to server. The specifying of the IP address and server port are required, see [Chap. A 3.3.11.1](#).
- **CLIENT/UDP**: Controller sends measured values via UDP/IP connectionless to server. Specifying the server's IP address and port is required.
- **IP**: IP address of the server, to which measured values are sent when in client-mode
- **Port**: Port, to which the server gets assigned to in server-mode or to which the measured values are sent in client-mode (min: 1024, max: 65535).

A 3.3.6.3 Setting the RS422 Baud Rate

```
BAUDRATE [<Baudrate>]
```

Baud rates can be set in Bps for the RS422 interface:

9600, 115200, 230400, 460800, 691200, 921600, 2000000, 3000000, 4000000

A 3.3.6.4 Change Ethernet / EtherCAT

```
ETHERMODE [ETHERNET | ETHERCAT]
```

Select whether the controller starts with Ethernet or EtherCAT mode.

The setting is active after save and reboot the controller only.

A 3.3.6.5 Measurements per frame

```
MEASCNT_ETH [0 | <count>]
```

Set the maximum frame number per packet for transmission of measurements via Ethernet.

0: Automatic assignment of the frame number per packet

count: Maximum number of frames per packet (0 ... 350)

A 3.3.6.6 TCP On/Off

```
TCPKEEPALIVE [ON|OFF]
```

The parameter can have the following states:

- **ON**: Enables the function "tcp keep alive"
- **OFF**: Disables the use of "cp keep alive"

A 3.3.7 Parameter Management, Load / Save Settings

A 3.3.7.1 Safe / Load Connection Settings

```
BASICSETTINGS READ | STORE
```

- **READ**: Reads the connection settings from the controller flash.
- **STORE**: Saves the current connection settings from the controller RAM into the controller flash.

A 3.3.7.2 Show Changed Parameters

```
CHANGESETTINGS
```

Outputs all changed settings.

A 3.3.7.3 Export of Parameter Sets to PC

```
EXPORT (MEASSETTINGS <SettingName>) | BASICSETTINGS |  
MEASSETTINGS_ALL | ALL)
```

Exporting of sensor settings.

- **MEASSETTINGS**: Only measurement settings named
- **<SettingName>** are transmitted.
- **BASICSETTINGS**: Only device settings are transmitted.
- **MEASSETTINGS_ALL**: All measurement settings are transmitted.
- **ALL**: All device and measurement settings are transmitted.

A 3.3.7.4 Import of Parameter Sets from PC

```
IMPORT [FORCE] [APPLY] <ImportData>
```

Loading parameters from external device, e.g. PC.

The import file is a JSON file that was stored before during the export.

- **FORCE**: Overwriting `Meassettings` with the same name, otherwise an error message is displayed when the name is the same. If all `Meassettings` or `Basicsettings` are imported, Force must always be specified.
- **APPLY**: Activates the settings after importing and reading the Initial Settings.
- **ImportData**: Data in JSON format

A 3.3.7.5 Default Settings

```
SETDEFAULT ALL | MEASSETTINGS | BASICSETTINGS | MATERIAL
```

Sets the default values (reset to factory setting), deletes the corresponding settings in the Flash.

- **ALL**: All setups are deleted and the default parameters are loaded. In addition, the current material table is overwritten with the standard material table.
- **MEASSETTINGS**: Deletes all measurement settings
- **BASICSETTINGS**: Deletes all basic settings
- **MATERIAL**: Overwrites only the current material table with the standard material table.

A 3.3.7.6 Editing, Storing, Displaying, Deleting Measurement Settings

MEASSETTINGS <Subcommand> [<Name>]

Settings for measurement task transferring application-dependent measurement settings between controller RAM and controller Flash. Either the presets specified by the manufacturer or the user-specific settings are used. Each preset can be used as user-specific setting.

Subcommands:

PRESETMODE <mode>	Defines the preset dynamics.
<mode> = NONE STATIC BALANCED DYNAMIC	NONE means that there is no selection for a preset.
PRESETLIST	Lists all existing presets (names): „Name1“ „Name2“ „...“
READ <Name>	Loads a basic setting or a meassetting / preset from the controller Flash.
STORE <Name>	Stores a basic setting or a meassetting in the controller Flash. If no name is specified, the setting is saved under the current name.
DELETE <Name>	Deletes the indicated measurement setting from the controller Flash.
RENAME <NameOld> <NameNew> [FORCE]	Changes the name of a measurement setting in the controller Flash. FORCE overwrites an existing measurement setting.
LIST	Lists all stored measurement settings (names) „Name1“ „Name2“ „...“. The order is defined by the internal slot numbers and not by the order as they were stored.
CURRENT	Output of all current meassettings / presets (name)
INITIAL AUTO	When starting the controller, the settings which were saved last or the first preset are loaded if no setups exist.
INITIAL <Name>	Loads the indicated measurement settings when starting the controller. Presets cannot be indicated.

A 3.3.8 Measurement

A 3.3.8.1 Measuring Rate

MEASRATE [<Messrate>]

Specifies the measuring rate in kHz, range 0.100 ... 6.000.

A maximum of three decimal places may be specified, e. g. 0.100 for 0.1 kHz.

A 3.3.8.2 Masking the Evaluation Ranges

ROI [<Start> [<End>]]

Can be used to limit the evaluation range.

Start and end must be between 0 and 511. The figure is given in pixels. The start value must be less than the end value.

A 3.3.8.3 Peak Detection Threshold

MIN_THRESHOLD [<n>]

Sets the minimum detection threshold. A peak must be above this threshold in order to be detected as peak.

It is entered in % and must be between 0.5 and 100. Precision can be specified with one decimal place.

A 3.3.9 Material Data Base

A 3.3.9.1 Material Table

```
MATERIALTABLE
```

Output of material table that is stored in the controller.

```
-> MATERIALTABLE
Material,    n_group,    Description
„Vacuum“,   1.000000,    „Perfect vacuum“
„Water“,    1.363000,    „liquid water (H2O) at 25C“
„Acrylic“,  14.97500,    „acrylic resin, adhesive, lacquer“
```

- Name: Name of material
- group index: Group refractory index of the material
- Description: Brief description of the material

A 3.3.9.2 Select Material

```
MATERIAL [<Material Name>]
```

Selecting the material to be used for the thickness peak (thickness sensor).
The command supports case sensitive inputs.

A 3.3.9.3 Display Material Properties

```
MATERIALINFO
```

Output of material properties of the selected layer.

```
->MATERIALINFO
Name:                Vacuum
group index:         1.000000
Description:         vacuum, air (approximately)
->
```

A 3.3.9.4 Edit Material Table

```
MATERIALEDIT <Name> <n_group> <Description>
```

Adding or editing a material.

- Name: Name of material
- group index: Group refractory index of the material (0.000000 ... 10.000000)
- Description: Description of the material, at least 2, at most 63 characters

The material table can include no more than 20 materials.

A 3.3.9.5 Material ergänzen

```
MATERIALADD <Material> <Phase_Index> <Group_Index> <Phase_Shift> <Description>
```

Adds a material.

Material: The name must start with an alphanumeric character and be between 2 and max. 31 characters long. Character range a-zA-Z0-9 ()-._.

- Phase_Index: The value range for the refractive index is between +1.000000 to +10.000000.
- Group_Index: The value range for the group refractive index is between +1.000000 to +10.000000.
- Phase_Shift: The value range for the phase index is between -3.141592 to +3.141592.
- Description: The description must start with an alphanumeric character and be between 2 and max. 31 characters long. Character range a-zA-Z0-9 ()-._.

A 3.3.9.6 Determining the Material Composition of the Target

```
MATERIALMP [<mat1> [<mat2> [<mat3> [<mat4> [<mat5>]]]]]]
```

Determines the layer composition of a target.

- mat11: close to sensor
- mat15: far from sensor

A 3.3.9.7 Defining a Medium in Front of the Target

```
MATERIAL_INFRONT [<Name>]
```

Defines or lists the medium between the sensor and the first layer of the target.

- Name: Name of the material or medium used, see [Chap. A 3.3.9.1](#).

A 3.3.9.8 Delete a Material

```
MATERIALDELETE <Name>
```

Delete a material.

- Name: Name of material (Length: max. 30 characters)

A 3.3.9.9 Number of Peaks

```
PEAKCOUNT [<Value>]
```

Determines or lists the number of peaks of the FFT signal used for evaluation in thickness measurement.

- Value: Specify number with 1 to max. 14 peaks

A 3.3.10 Measurement Value Processing

A 3.3.10.1 List of Possible Thickness Signals for Statistical Calculation

```
META_STATISTICSIGNAL
```

Lists all possible thickness signals that can be used to calculate statistical signals.

A 3.3.10.2 Generate Statistic Signals

```
STATISTICSIGNAL <signal> NONE | INFINITE | <depth>
```

- <signal>: Thickness signal for which statistical values are to be calculated
- NONE: Ends statistical calculation for the corresponding thickness signal
- INFINITE: Uses all previous measurement values as evaluation range for the statistical calculation
- <depth>: Evaluation range for statistical calculation, 2|4|8|...|8192|16384

Statistics are generated for this selected signal.

The controller generates new signals that can then be output via the interfaces.

- <signal>_MIN: Signal minimum
- <signal>_MAX: Signal maximum
- <signal>_PEAK: <signal>_max - <signal>_min

Command examples:

```
STATISTICSIGNAL returns the list of configured statistical signals
```

```
STATISTICSIGNAL <signal> returns the configuration of the specified signal
```

A 3.3.10.3 List of Statistical Signals

```
META_STATISTIC
```

Displays a list of the active statistical signals.

These signals were defined under `STATISTICSIGNAL`.

A 3.3.10.4 Reset Statistical Calculation

```
STATISTIC ALL | <signal> RESET
```

Resets the statistical data of the selected signal or of all signals (minimum, maximum, peak).

- <signal>: Resets the statistical data of the corresponding thickness signal
- ALL: Resets all statistical data

A 3.3.10.5 Statistics Example

The commands are executed with the Telnet program, no statistical values have been defined.

```
->o 169.254.168.150
```

```

.-----
/         \
/ |   | /   )\
| |   | \___ |
| |   | /   |
\ | \_ / | \___ )/
      ,|

```

Connected with the MICRO-OPTRONIC terminal server.
Your IP 169.254.168.1, your local port number 51719. You
are connected to port number 23.

->META_STATISTICSIGNAL META_STATISTICSIGNAL 01PEAK01	// List of all controller signals that can be used to calculate statistical signals.
->STATISTICSIGNAL 01PEAK01 256	// Use the last 256 values of the signal 01PEAK01 to calculate the statistical values 01PEAK01_MIN, 01PEAK01_MAX and 01PEAK01_PEAK
->STATISTICSIGNAL STATISTICSIGNAL 01PEAK01 256 STATISTICSIGNAL NONE STATISTICSIGNAL NONE ... STATISTICSIGNAL NONE	// List all 10 possible variables and show their state. // In the web interface, go to the <code>Measurement chart</code> tab to show the statistical signals.
->OUT_ETH 01PEAK01_MIN	// Selects the minimum value for output via the Ethernet interface.
->OUTPUT ETHERNET	// Activates output via Ethernet.
->STATISTICSIGNAL 01PEAK01 NONE W526 Output signal selection modified by the system	// Ends statistical calculation for the signal 01PEAK01

A 3.3.10.6 List of Signals which can be Parameterized

```
META_MASTERSIGNAL
```

Lists all possible signals which can be used for mastering.

A 3.3.10.7 Master Signal Parameterization

```
MASTERSIGNAL [<signal>]
```

```
MASTERSIGNAL [<signal> <master_value>]
```

```
MASTERSIGNAL [<signal> NONE]
```

Defines and configures the signal to be mastered.

The `NONE` parameter resets the signal.

- `<signal>`: Selecting a specific measured or calculated signal on which the master value should be set
- `<master value>`: Master value in mm, value range: -21.47 ... 21.47

A 3.3.10.8 List of Possible Signals for Mastering

```
META_MASTER
```

Lists all defined master signals from the `MASTERSIGNAL` command and can be used with the `MASTER` command.

A 3.3.10.9 Masters / Zero

```
MASTER [<signal>]
```

```
MASTER [ALL|<signal> SET|RESET]
```

Up to 10 master signals are in the controller which can be applied on all internally determined values and calculated values.

This command sets/resets the mastering process for the corresponding signal.

- `ALL`: Use all signals for mastering
- `<signal>`: Use a specific measured or calculated signal for the mastering process
- `SET|RESET`: Start or stop the function

If the master value is 0, the mastering function has the same functionality as the zero setting.

The master command waits for a maximum of 2 seconds for the next measurement value and uses this as master value. If no value is measured within this time, e.g. in case of external triggering, the command returns with the error „E32 Timeout“.

The master value is processed with six decimal places.

A 3.3.10.10 Mastering Example

The commands are executed with the Telnet program, no variables defined.

```
->o 169.254.168.150
```

```

.-----
/           \
/ |   | /   )\
| |   | \___ |
| |   | /   |
\ | \_ / | \___)/
      ,|

```

Connected with the MICRO-OPTRONIC terminal server.
Your IP 169.254.168.1, your local port number 51719 and
you are connected to port number 23

<pre>->META_MASTERSIGNAL</pre>	// Lists all variables which can be mastered
<pre>META_MASTERSIGNAL 01PEAK01</pre>	

->META_MASTER META_MASTER NONE	// Lists all variables which are assigned with a master value
->MASTERSIGNAL 01PEAK01 0.422	// Setting Variable 01PEAK01 to 422 μm
->META_MASTER META_MASTER 01PEAK01	// Lists all variables which are assigned with a master value; the variables 01PEAK01 is now assigned with a master value
->MASTER ALL MASTER 01PEAK01 INACTIVE MASTER NONE MASTER NONE MASTER NONE ... MASTER NONE MASTER NONE MASTER NONE MASTER NONE	// Lists the 10 possible variables and shows their status <div style="border: 1px solid blue; padding: 5px; display: inline-block; margin: 10px 0;">01PEAK01 401.91556 μm</div>
->MASTER ALL SET	// Triggers a master measurement for all assigned variables <div style="border: 1px solid blue; padding: 5px; display: inline-block; margin: 10px 0;">01PEAK01 422.00094 μm</div>
->MASTER 01PEAK01 RESET	// Resets the offset (master value) for the variable 01PEAK01 <div style="border: 1px solid blue; padding: 5px; display: inline-block; margin: 10px 0;">01PEAK01 401.91556 μm</div>
->MASTER ALL MASTER 01PEAK01 INACTIVE MASTER NONE MASTER NONE MASTER NONE ... MASTER NONE MASTER NONE MASTER NONE MASTER NONE	
->MASTERSIGNAL 01PEAK01 NONE	// The variable 01PEAK01 is deleted
->MASTER ALL MASTER NONE ... MASTER NONE	// No variable on which a master measurement could be applied

A 3.3.10.11 Channel Computation

```

COMP [<channel> [<id>]]
COMP CH01 <id> MEDIAN <signal1> <median data count>
COMP CH01 <id> MOVING <signal1> <moving data count>
COMP CH01 <id> RECURSIVE <signal1> <recursive data count>
COMP CH01 <id> CALC <factor1> <signal1> <factor2> <signal2> <offset> <name>
COMP CH01 <id> THICKNESS <signal1> <signal2> <name>
COMP CH01 <id> COPY <signal1> <name>
COMP CH01 <id> NONE

```

This command defines all controller-specific calculations.

- <id> 1 ... 10 *Number of calculation block; a maximum of 10 calculation blocks are possible. The ID is assigned in ascending order. The calculation blocks are processed sequentially. Feedback couplings (algebraic loops) over one or several blocks are not possible.*
- <signal1>, <signal2> *Measurement signal; query the available signals with the META_COMP command*
- <median data count> 3|5|7|9 *Averaging depth Median*
- <moving data count> 2|4|8|16|32|64|128|256|512|1024|2048|4096 *Averaging depth of moving average*
- <recursive data count> 2 ... 32000 *Averaging depth of recursive average*
- <factor1>, <factor2> *-32768.0 .. 32767.0 (unit mm)*
- <offset> *-21.47 .. 21.47 (unit mm)*
- <name> *Name of calculation block; min. length 2 characters, max. length 15 characters Permitted characters a-zA-Z0-9, the name must begin with a letter.*
Command names are not permitted, e.g. STATISTIC, MASTER, NONE, ALL.

The COMP command enables you to create, modify and delete calculation blocks.

Functions:

- MEDIAN, MOVING and RECURSIVE : Averaging functions
- CALC: Calculation function consisting of two addends (signal), sign/scaling (factor) and a constant (offset); formula:

$$\text{CALC} = (\text{factor1} * \text{signal}) + (\text{factor2} * \text{signal}) + \text{offset}$$
The result of the calculation is written to a new variable <name>.
- THICKNESS: Thickness calculation (difference) from two peaks, Signal1 > Signal2;
formula: THICKNESS = <signal1> - <signal2>
The result of the calculation is written to a new variable <name>.
- COPY : Duplicates a signal
- NONE : Deletes a calculation block

A 3.3.10.12 List of possible calculation signals

```
META_COMP [CH01 <id>]
```

Lists all possible signals which can be used in the calculation.

```
<id> 1 ... 10
```

A 3.3.11 Data Output

A 3.3.11.1 Selection of Digital Output

```
OUTPUT [NONE | ([RS422] [ETHERNET] [ANALOG] [ERROROUT])]
```

- NONE: No measurement value output
- RS422: Output of measurement values via RS422
- ETHERNET: Output of measurement values via Ethernet
- ANALOG: Output of measurement values via analog output
- ERROROUT: Error or status information about the switching outputs

Command starts the measurement value output. If not yet done, connect the controller now to the measurement server.

A 3.3.11.2 Data Output Rate

```
OUTREDUCEDEVICE [NONE | ([RS422] [ANALOG] [ETHERNET])]
```

The number of measured values is reduced using the selected interfaces.

- NONE: No reduction of measurement value output
- RS422: Reduction of measurement value output via RS422
- ANALOG: Reduction of measured values output via analog
- ETHERNET: Reduction of measurement value output via Ethernet

A 3.3.11.3 Reduction Counter of Measurement Value Output

```
OUTREDUCECOUNT [<Number>]
```

Reduction counter of measurement value output.

Only every n-th measured value is output. n-1 measured values are canceled.

- Number: 1 ... 3000000 (1 means all frames)

A 3.3.11.4 Error Processing

```
OUTHOLD [NONE | INFINITE | <Number>]
```

If no valid measured value can be determined, an error is output.

- NONE: No holding the last measurement value, output of error value
- INFINITE: Infinite holding of the last measurement value
- Number: Holding the last measurement value on the number of measuring cycles; then an error value (maximum of 1024) is output.

A 3.3.12 Select Measurement Values to be Output

A 3.3.12.1 General

Setting the values to be output via the Ethernet interface.

The maximum output rate via the Ethernet interface depends on the number of output values.

A 3.3.12.2 Data Selection of Ethernet

```
OUT_ETH [<signal1>] [<signal2>] ... [<signalN>]
```

Describes which data are output via these interfaces.

A 3.3.12.3 List of Possible Ethernet Signals

```
META_OUT_ETH [MEAS | VIDEO | CALC]
```

List of possible data for Ethernet.

The parameter `Video` contains the FFT signal.

Additional activation using the `OUTPUT` command (see Chap. A 3.3.11.1) is required.

A 3.3.12.4 List of Selected Signals, Transfer Sequence via Ethernet

```
GETOUTINFO_ETH
```

Indicates the signal sequence via these interfaces.

A 3.3.13 Switching Outputs

A 3.3.13.1 Error Switching Outputs

```
ERROROUT1 [01ER1 | 01ER2 | 01ER12 | ERRORLIMIT]
```

```
ERROROUT2 [01ER1 | 01ER2 | 01ER12 | ERRORLIMIT]
```

Setting the error switching outputs.

Additional activation using the `OUTPUT` command is required, see [Chap. A 3.3.11.1](#).

- `01ER1`: Switching output is switched in case of signal quality error
- `01ER2`: Switching output is switched in case of a measured value outside of the measuring range
- `01ER12`: Switching output is switched in case of a signal quality error or a measured value outside of the measuring range
- `ERRORLIMIT`: Function as limit value switch with the settings `ERRORLIMIT-SIGNAL1`, `ERRORLIMITCOMPARE01`, `ERRORLIMITVALUES1`

A 3.3.13.2 Setting the Signal to be Evaluated

```
ERRORLIMITSIGNAL1 [<signal>]
```

Selecting the signal which should be used for the limit value consideration number 1.

```
ERRORLIMITSIGNAL2 [<signal>]
```

Selecting the signal which should be used for the limit value consideration number 2.

A 3.3.13.3 List of Possible Signals for Error Output

```
META_ERRORLIMITSIGNAL
```

List with all possible signals that could have effects on the error outputs.

A 3.3.13.4 Setting Limit Values

```
ERRORLIMITCOMPARETO1 [LOWER | UPPER | BOTH]
```

Outputting or setting limit value number 1.

```
ERRORLIMITCOMPARETO2 [LOWER | UPPER | BOTH]
```

Outputting or setting limit value number 2.

- `LOWER`: Shortfall
- `UPPER`: Exceedance
- `BOTH`: Shortfall or exceedance

A 3.3.13.5 Setting Value

```
ERRORLIMITVALUES1 [<lower_limit> [<upper_limit>]]
```

Sets the values for limit value 1.

```
ERRORLIMITVALUES2 [<lower_limit> [<upper_limit>]]
```

Sets the values for limit value 2.

- `<lower_limit>`: -21,47 ... 21,47
- `<upper_limit>`: -21,47 ... 21,47

Unit in mm

A 3.3.13.6 Switching Behavior for Error Outputs

```
ERRORLEVELOUT1 [PNP | NPN | PUSHPULL | PUSHPULLNEG]
```

```
ERRORLEVELOUT2 [PNP | NPN | PUSHPULL | PUSHPULLNEG]
```

Switching behavior of error outputs Error 1 and Error 2.

- `PNP`: Switching output is High in the case of an error and open without error
- `NPN`: Switching output is Low in the case of an error and open without error
- `PUSHPULL`: Switching output is High in the case of an error and Low without error
- `PUSHPULLNEG`: Switching output is Low in the case of an error and High without error

A 3.3.14 Analog Output

A 3.3.14.1 Data Selection

```
ANALOGOUT [<Signal>]
```

Selection of the signal which should be output via the analog output. As parameter, the signal is indicated. A list of possible signals can be seen with `META_ANALOGOUT`.

Additional activation using the `OUTPUT` command is required, see [Chap. A 3.3.11.1](#).

A 3.3.14.2 List of Possible Signals for Analog Output

```
META_ANALOGOUT
```

Lists all signals that can be sent to the analog output.

A 3.3.14.3 Output Range

```
ANALOGRANGE [0-5V | 0-10V | 4-20mA]
```

- 0 - 5 V: The analog output outputs a voltage of 0 to 5 volts.
- 0 - 10 V: The analog output outputs a voltage of 0 to 10 volts.
- 4 - 20 mA: The analog output outputs a current of 4 to 20 mA.

A 3.3.14.4 Setting the Scaling of DAC

```
ANALOGSCALEMODE [STANDARD | TWOPOINT]
```

Decides between either a one-point or two-point scaling of the analog output.

- STANDARD: One-point scaling
- TWOPOINT: Two-point scaling

The default scaling is for displacements $-MR/2$ up to $MR/2$ and for thickness measurement on 0 up to 2 MR (MR=Measuring range).

Minimum and maximum measured values must be specified in millimeters. The available output range of the analog output is then spread between the minimum and maximum measured values. The minimum and maximum measured values must be between -21.47 and 21.47.

The minimum and maximum measured value is processed with two decimal places.

Unit in mm

A 3.3.14.5 Setting the Scaling Range

```
ANALOGSCALERANGE [<lower_limit> < upper_limit>]
```

<lower_limit> and <upper_limit> must be between -21.47 and 24.47 and cannot be identical.

Unit in mm

A 3.3.15 Key Functions

A 3.3.15.1 Multifunction Button

KEYFUNC1 [NONE|MASTERSET|MASTERRESET|PILOTLASER|SLED]

Configuring the button for the interval pressed 1 (0 ... 2 s)

- NONE: No function
- MASTERSET: The MASTER SET command is triggered (see command `Master`) for signals that have been defined by KEYMASTERSIGNALSELECT.
- MASTERRESET: The MASTER RESET command is executed (set command MASTER) for signals that have been defined by KEYMASTERSIGNALSELECT.
- PILOTLASER: The button is used to switch the pilot laser.
- SLED: The button is used to switch the SLED.

KEYFUNC2 [NONE|MASTERSET|MASTERRESET|PILOTLASER|SLED]

Configuring the button for the interval pressed 2 (2 ... 5 s)

- NONE: No function
- MASTERSET: The MASTER SET command is triggered (see command `Master`) for signals that have been defined by KEYMASTERSIGNALSELECT.
- MASTERRESET: The MASTER RESET command is executed (set command MASTER) for signals that have been defined by KEYMASTERSIGNALSELECT.
- PILOTLASER: The button is used to switch the pilot laser.
- SLED: The button is used to switch the SLED.

A 3.3.15.2 Signal Selection for Mastering with Multifunction Button

KEYMASTERSIGNALSELECT [ALL | NONE | <signal> [<signal2> [...]]]

Selection of measuring data signals for the master via the button (see KEYFUNC1 and KEYFUNC2). A list of available signals is provided by the META_MASTER command. The signals are configured using the MASTERSIGNAL command.

A 3.3.15.3 Key Lock

KEYLOCK [NONE | ACTIVE | (AUTO [<timeout period>])]

Key lock configuration

- NONE: Key is active, no key lock.
- ACTIVE: Key lock is activated immediately after restart.
- AUTO: Key lock is activated only <time> seconds after restart.
<time period> minutes (1 ... 60)

A 3.4 Measured Value Format

A 3.4.1 Structure

The structure of measurement frames, see [Chap. A 3.5.1.2](#), depends on the selected measurement values. See below for a summary of commands which enable you to query the available measurement values via Ethernet.

Chap. A 3.3.12.2	OUT_ETH	Data selection for Ethernet
Chap. A 3.3.12.3	META_OUT_ETH	List of Possible Ethernet Signals
Chap. A 3.3.12.4	GETOUTINFO_ETH	List of Selected Signals, Transfer Sequence via Ethernet

Example for the structure of a data block, query via Telnet:

<pre>Preset Standard reflective ->META_OUT_ETH META_OUT_ETH 01ABS 01SHUTTER 01ENCODER1 01ENCODER2 01PEAK01 MEASRATE TIMESTAMP COUNTER STATE -></pre>
<pre>->GETOUTINFO_ETH GETOUTINFO_ETH 01PEAK01 -></pre>

A measured value frame is built dynamically, i.e., values not selected are not transmitted.

A 3.4.2 Exposure Time

The data word to the exposure time is 32-bit wide during transmission via Ethernet. The resolution is 100 ns.

A 3.4.3 Encoder

The encoder values for transmission can be selected individually. A 32 bit data word (unsigned integer) with the encoder position is output via Ethernet.

A 3.4.4 Measured Value Counter

The transmission of the measured value counter via Ethernet is effected as 32 bit value (unsigned integer).

A 3.4.5 Time Stamp

Intrasystem the resolution of time stamp is 1 μ s. For the Ethernet transfer a 32 bit data word (unsigned integer) with the intrasystem resolution is output.

A 3.4.6 Measurement Data (displacements and signal quality)

An signal quality (if selected) and a measurement value are transmitted for each selected thickness. For the Ethernet transmission 32 bit for each are used. The structure of the intensity data word is shown in the following table. The thickness values resolution is 10 pm on the Ethernet channel, signed output.

Bit position	Description
0 - 10	Signal quality of peak (100 % comply with 2048)
11 - 15	Reserved
16 - 29	Maximum of peak
30 - 31	Reserved

Fig. 76 Bit structure signal quality

A 3.4.7 Trigger Time Difference

The trigger time difference is output via Ethernet as an unsigned 32 bit integer with a resolution of 100 ns.

Range: 0 ... 100000

A 3.4.8 Statistical values

A statistical value has the same format as the thickness.

The transmission sequence (if selected) starts with minimum, then maximum and peak-to-peak.

Statistical values are provided as 32 bit signed integer with 1 nm resolution.

A 3.5 Measurement Data Format

A 3.5.1 Measurement Data transmission to a Server via Ethernet

A 3.5.1.1 General

During the measurement data transmission to a measurement value server the sensor transmits each measurement value to the measurement value server or to the connected client after successful connection (TCP or UDP). Therefore no explicit requirement is necessary.

Any thickness and additional information to be transmitted that are logged at one point in time are combined to form a value frame. Different measurement value frames are combined to a measurement value block, which contains a header and fits a TCP/IP or UDP/IP packet. The header is mandatory at the start of a UDP or TCP packet. In case of changes of the transferred data or the frame rate a new header is automatically sent.

All measurement data and the header are transmitted in the little Endian format.

Preamble (32 Bit)
Order number (32 Bit)
Serial number (32 Bit)
Length FFT data (32 Bit)
Length measurement data (32 Bit)
Frame number (32 Bit)
Counter (32 Bit)

The structure of a header for FFT and measurement data transfer is the same.

Header entry	Description
Preamble	uint32_t - 0x41544144 "DATA"
Order number	
Serial number	
Length FFT data	[Byte]
Length measurement data	[Byte]
Frame number	Number of frames, that cover this header. With FFT output, the field for the number of measurement data frames is set to one in the packet.
Counter	Counter on the number of processed measurement values

Example: The data encoder 1 and thickness are transmitted.

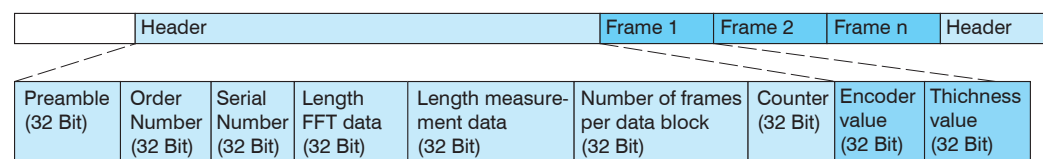

Fig. 77 Example for data transmission with Ethernet

A 3.5.1.2 Measurement Frame

A data packet typically contains one or more measurement data frames.

A measurement data frame comprises one or more signals. The content of a measurement data frame can be set using the `out_eth` command. `getoutinfo_eth` queries the structure of a measurement frame.

out_eth Parameter	Signal designation	Data type/ range	Scaling	Unit
01ABS	Magnitude signal	512 x uint16_t 0 ... 4095	-	ADC Digits
01SHUTTER	Exposure time channel 1	uint32_t 10 ... 100000	value / 10	μ s
01ENCODER1	Encoder 1 channel 1	uint32_t 0 ... 2^{32-1}	-	Ticks
01ENCODER2	Encoder 2 channel 1	uint32_t 0 ... 2^{32-1}	-	Ticks
01PEAK01	Thickness value	int32_t -2^{32-1} ... $+2^{32-1}$	10	pm
MEASRATE	Sample rate	uint32_t 1538 ... 100000	$10 \cdot 1000 / \text{value}$	kHz
TIMESTAMP	Time stamp	uint32_t 0 ... 2^{32-1}	value / 1000000	s
COUNTER	Measurement frame counter	uint32_t 0 ... 2^{32-1}		
STATE	State word	uint32_t 0 ... 2^{32-1}	-	-

A 3.5.1.3 State Word

STATE represents the inputs, the outputs, the LEDs and the trigger information.

Bit	LED															
	31	30	29	28	27	26	25	24	23	22	21	20	19	18	17	16
			Phy2		Phy1		Status		Pilot		SLED		Range		Intensity	
											00 _b (0)		Off			
											01 _b (1)		Green			
											10 _b (2)		Red			
											11 _b (3)		Yellow			

Bit	Trigger Signal		I/O						Trigger In		Encoder					
	15	14	13	12	11	10	9	8	7	6	5	4	3	2	1	0
	Ts		Sync / Trigger	Sync / Trigger Enable	Out2	Out2 enable	Out1	Out1 enable	Tr		A1	B1	N1	A2	B2	N2
0 _b (0)	No triggering								0 _b (0)	Input or output not active						
1 _b (1)	Triggering done								1 _b (1)	Input or output active						

A 3.5.1.4 Example

The example below outputs the exposure time, measured value and the associated time stamp.

- Set the signals with `OUT_ETH`:

```
OUT_ETH 01SHUTTER 01PEAK01 TIMESTAMP
```

- Query the signal sequence in the measurement frame:

```
GETOUTINFO_ETH 01PEAK01 01SHUTTER TIMESTAMP
```

- Start the output:

```
OUTPUT Ethernet
```

A 3.5.1.5 Error Codes Ethernet Interface

Within the thickness values, see [Chap. A 3.5.1.2](#), a range from 0x7FFFFFF00 to 0x7FFFFFFF is reserved for error values/codes. The following error codes are defined:

Error code	Description
0x7FFFFFF04	There is no peak present
0x7FFFFFF05	Peak is located in front of the measuring range (MR)
0x7FFFFFF06	Peak is located behind of the measuring range (MR)
0x7FFFFFF07	Measuring value cannot be calculated
0x7FFFFFF08	Measuring value outside presentable area
0x7FFFFFF0E	Error hardware

A 3.5.2 Ethernet FFT Signal Transmission

The FFT signal transmission is effected to a measurement value server via Ethernet analog to the measurement data transmission, except, that only one FFT signal is transmitted in a measurement value block.

This measurement value block can vary also over different TCP/IP or UDP/IP packets depending on the size of the FFT signal. The preamble for the FFT signals is 0x41544144 "DATA".

Request a FFT signal:

Use the command `OUT_ETH`.

- `OUTPUT ETHERNET`: Output via Ethernet

A 3.6 Warning and Error Messages

E200 I/O operation failed

E202 Access denied

E204 Received unsupported character

E205 Unexpected quotation mark

E210 Unknown command

E212 Command not available in current context

E214 Entered command is too long to be processed

E230 Unknown parameter

E231 Empty parameters are not allowed

E232 Wrong parameter count

E233 Command has too many parameters

E234 Wrong or unknown parameter type

E236 Value is out of range or the format is invalid

E262 Active signal transfer, please stop before

E270 No signals selected

E272 Invalid combination of signal parameters, please check measure mode and signal selection

E276 Given signal is not selected for output

E277 One or more values were unavailable. Please check output signal selection

E281 Not enough memory available

E282 Unknown output signal

E283 Output signal is unavailable with the current configuration

E284 No configuration entry was found for the given signal

E285 Name is too long

E286 Names must begin with an alphabetic character, and be 2 to 15 characters long. Permitted characters are: a-zA-Z0-9_

- E320 Wrong info-data of the update
- E321 Update file is too large
- E322 Error during data transmission of the update
- E323 Timeout during the update
- E324 File is not valid for this sensor
- E325 Invalid file type
- E327 Invalid checksum
- E331 Validation of import file failed
- E332 Error during import
- E333 No overwrite during import allowed
- E340 Too many output values for RS422 selected
- E350 The new passwords are not identical
- E351 No password given
- E360 Name already exists or not allowed
- E361 Name begins or ends with spaces or is empty
- E362 Storage region is full
- E363 Setting name not found
- E364 Setting is invalid
- E500 Material table is empty
- E502 Material table is full
- E504 Material name not found
- E600 ROI begin must be less than ROI end
- E602 Master value is out of range
- E603 One or more values were out of range
- E610 Encoder: minimum is greater than maximum
- E611 Encoder's start value must be less than the maximum value
- E615 Synchronization as slave and triggering at level or edge are not possible at the same time
- E616 Software triggering is not active
- E618 Sensor head not available
- E621 The entry already exists
- E622 The requested dataset/table doesn't exist.
- E623 Not available in EtherCAT mode
- E624 Not allowed when EtherCAT SYNC0 synchronization is active

- W505 Refractivity correction deactivated, vacuum is used as material
- W526 Output signal selection modified by the system
- W528 The shutter time has been changed to match the measurement rate and the system requirements.
- W530 The IP settings has been changed.

A 4 EtherCAT Documentation

A 4.1 General

EtherCAT® is, from the Ethernet viewpoint, a single, large Ethernet station that transmits and receives Ethernet telegrams. Such an EtherCAT system consists of an EtherCAT master and up to 65,535 EtherCAT slaves.

Master and slaves communicate via standard Ethernet wiring. On-the-fly processing hardware is used in each slave. The incoming Ethernet frames are directly processed by the hardware. Relevant data are extracted from the frame or used based on the frame. The frame is then sent on to the next EtherCAT® slave device. The last slave device sends back the fully processed frame. Various protocols can be used on application level. CANopen over EtherCAT technology (CoE) is supported here. The CANopen protocol uses an object tree with Service Data Objects (SDOs) and Process Data Objects (PDOs) to manage the data. Further information can be obtained from ® Technology Group (www.ethercat.org) or Beckhoff GmbH (www.beckhoff.com).

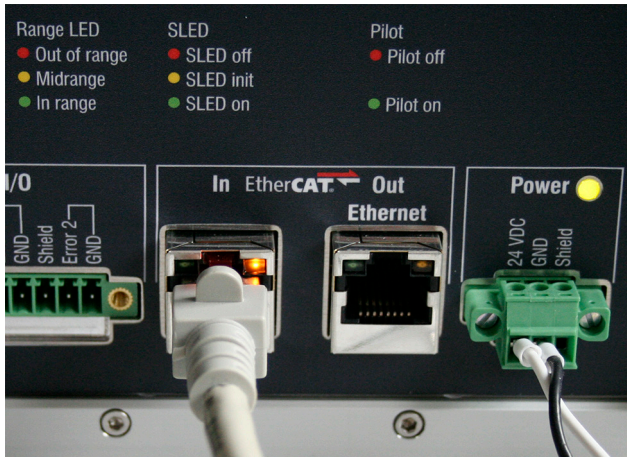
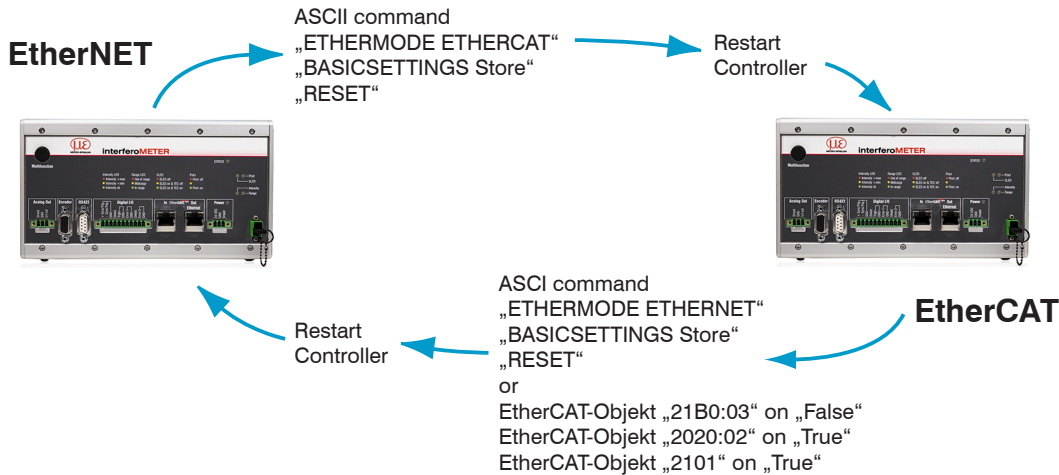

Fig. 78 Connecting the controller to the EtherCAT master

A 4.2 Switching between Ethernet and EtherCAT

You can switch between Ethernet and EtherCAT using an ASCII command, see [Chap. A 3.3.6.4](#), the web interface, see [Chap. 7.6.10](#) or an EtherCAT object, see [Chap. A 4.4.2.20](#). Save the current settings before switching to EtherCAT. The switch becomes active only after the controller has been restarted.



The RS422 interface for sending an ASCII command is available both in Ethernet mode and in EtherCAT mode.

A 4.3 Introduction

A 4.3.1 Structure of EtherCAT® Frames

Data are transferred in Ethernet frames with a special Ether type (0x88A4). Such an EtherCAT® frame consists of one or several EtherCAT® telegrams, each of which is addressed to individual slaves/storage areas. The telegrams are either transmitted directly in the data area of the Ethernet frame or in the data area of the UDP datagram. An EtherCAT® telegram consists of an EtherCAT® header, the data area and the work counter (WC). The work counter is incremented by each addressed EtherCAT® slave that exchanged the corresponding data.

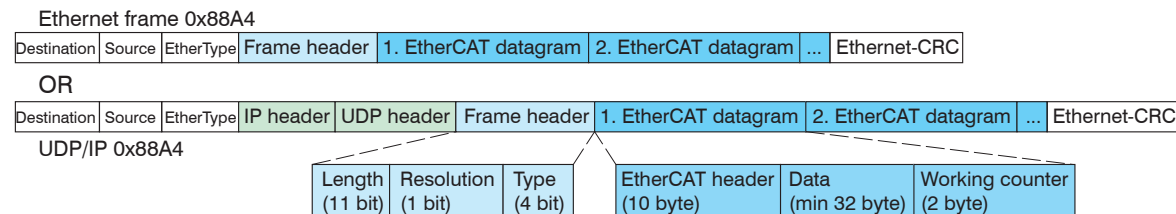

Fig. 79 Design of EtherCAT frames

A 4.3.2 EtherCAT® Services

Within EtherCAT®, the services for reading and writing data are specified in the physical memory of the slave hardware. The following EtherCAT® services are supported by the slave hardware:

- APRD (Auto-Increment Physical Read, reading of a physical area with auto-increment addressing)
- APWR (Auto-Increment Physical Write, writing of a physical area with auto-increment addressing)
- APRW (Auto-Increment Physical Read Write, reading and writing of a physical area with auto-increment addressing)
- FPRD (Configured Address Read, reading of a physical area with fixed addressing)
- FPWR (Configured Address Write, writing of a physical area with fixed addressing)
- FPRW (Configured Address Read Write, reading and writing of a physical area with fixed addressing)
- BRD (Broadcast Read, broadcast-reading of a physical area for all slaves)
- BWR (Broadcast Write, broadcast-writing of a physical area for all slaves)
- LRD (Logical Read, reading of a logical storage area)
- LWR (Logical Write, writing of a logical storage area)
- LRW (Logical Read Write, reading and writing of a logical storage area)
- ARMW (Auto-Increment Physical Read Multiple Write, reading of a physical area with auto-increment addressing, multiple writing)
- FRMW (Configured Address Read Multiple Write, reading of a physical area with fixed addressing, multiple writing)

A 4.3.3 Addressing and FMMUs

The master can use a variety of methods to address a slave in the EtherCAT® system. The IMS5x00 supports as full slave:

- Position addressing
The slave device is addressed via its physical position in the EtherCAT® segment.
The services used for this are APRD, APWR, APRW.
- Node addressing
The slave device is addressed via a configured node address, which was assigned by the master during the commissioning phase. The services used for this are FPRD, FPWR and FPRW.
- Logical addressing
The slaves are not addressed individually; instead, a segment of the segment-wide logical 4-GB address is addressed.
This segment can be used by a number of slaves.
The services used for this are LRD, LWR and LRW.

The local assignment of physical slave memory addresses and logical segment-wide addresses is implemented via the Fieldbus Memory Management Units (FMMUs). The configuration of the slave FMMUs is implemented by the master. The FMMU configuration contains a start address for the physical memory in the slave, a logical start address in the global address space, length and type of the data, as well as the direction (input or output) of the process data.

A 4.3.4 Sync Managers

Sync managers support data consistency during the data exchange between EtherCAT® master and slaves. Each sync manager channel defines a specific application memory area. The interfeROMETER has four channels:

- Sync manager channel 0: Sync manager 0 is used for mailbox write transfers (mailbox from master to slave).
- Sync manager channel 1: Sync manager 1 is used for mailbox read transfers (mailbox from slave to master).
- Sync manager channel 2: Sync Manager 2 is typically used for process output data. Not used in the controller.
- Sync manager channel 3: Sync Manager 3 is typically used for process input data. It contains the Tx PDOs that are specified by the PDO assignment object 0x1C13 (hex.).

A 4.3.5 EtherCAT State Machine

The EtherCAT® state machine is part of each EtherCAT® slave. Directly after switching on the interfeROMETER, the state machine is in the “initialization” state. In this state, the master has access to the DLL information register of the slave hardware. The mailbox is not yet initialized, i.e. communication with the application (controller software) is not yet possible. During the transition to the pre-operational state, the sync manager channels are configured for mailbox communication. In the pre-operational state, communication via the mailbox is possible and the object directory and its objects can be accessed. In this state, no process data communication occurs. During the transition to the safe-operational state, the master configures the process-data mapping, the sync manager channel of the process inputs and the corresponding FMMU. Mailbox communication continues to be supported in the safe-operational state. Process data communication is enabled for the inputs. The outputs are in a “safe” state. In the operational state, process data communication is enabled for inputs and outputs.

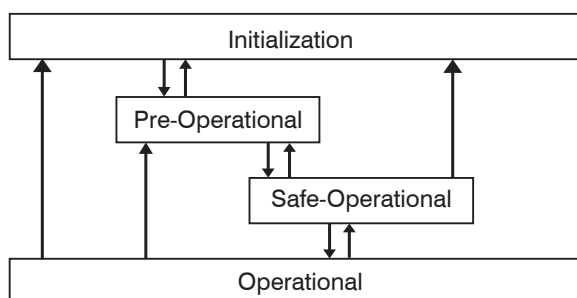

Fig. 80 EtherCAT State Machine

A 4.3.6 CANopen over EtherCAT

The application level communication protocol in EtherCAT is based on the communication profile CANopen DS 301. It is called “CANopen over EtherCAT” or CoE. The protocol specifies the object directory in the controller as well as the communication objects for the exchange of process data and acyclic messages. The controller uses the following message types:

- Process Data Object (PDO). The PDO is used for cyclic I/O communication (i. e. for process data).
- Service Data Object (SDO). The SDO is used for acyclic data transfer.

The object directory is described in Chapter “CoE Object Directory”, see [Chap. A 4.4.](#)

A 4.3.7 Process Data Object Mapping (PDO Mapping)

Process data objects (PDOs) are used for the exchange of time-critical process data between master and slave. To transmit data from the slave to the master, Tx PDOs are used (inputs). Rx PDOs are used to transfer data from the master to the slave (outputs); this concept is not used in the interferoMETER. The PDO mapping defines which application objects (measurement data) are transmitted into a PDO.

The interferoMETER lets the user choose from a selection of Tx PDO mapping objects, see [Chap. A 4.4.1.7.](#)

In EtherCAT the PDOs are transported in sync manager channel objects. The controller uses the sync manager channel SM3 for input data (Tx data). The PDO assignments of the sync manager can only be modified in the pre-operational state.

Note: Sub-index 0x00 of the object 0x1A00 contains the number of valid entries within the mapping report. This figure also represents the number of application variables (parameters) that should be transmitted/received with corresponding PDO. The sub-indices from 1h up to the number of objects contain information about the depicted application variables. The mapping values in the CANopen objects are coded in hexadecimal form.

The following table contains an example of the entry structure for the PDO mapping:

MSB			LSB		
31	16	15	8	7	0
Index e. g. 0x6000 (16 Bit)		Sub-index z.B. 0x01		Object length in bits, e. g. 20h = 32 bits	

Fig. 81 Sample entry structure for the PDO mapping

A 4.3.8 Service Data SDO Service

Service Data Objects (SDOs) are primarily used for the transmission of data that are not time-critical, e.g. parameter values.

EtherCAT specifications

- SDO services make possible the read/write access to entries in the CoE object directory of the device.
- SDO information services make it possible to read the object directory itself and to access the properties of the objects.

All parameters of the measuring device can be read or changed in this way, and measurements can be transmitted. A desired parameter is addressed via index and sub-index within the object directory.

A 4.4 CoE Object Directory

The CoE object directory (CANopen over EtherCAT) contains all configuration data of the controller. The objects in the CoE object directory can be called with the SDO services. Each object is addressed based on a 16-bit index.

A 4.4.1 Communication-Specific Standard Objects

A 4.4.1.1 Overview

Index (h)	Name	Description
1000	Device type	Device type
1008	Device name	Manufacturer's device name
1009	Hardware version	Hardware version
100A	Software version	Software version
1018	Identity	Device identification
1A00 ... 1BAB		TxPDO Mapping, see Chap. A 4.4.1.7 PDO mapping objects may contain merged process data (mappable objects).
1C00	Sync. manager type	Type of synchronization manager
1C12	RxPDO assign	
1C13	TxPDO assign	TxPDO assign
1C33	Sync manager input parameter	Synchronous mode parameter (DC)

Fig. 82 Standard objects - Overview

A 4.4.1.2 Object 1000h: Device Type

1000	VAR	Device type	0x00000000	Unsigned32	ro
------	-----	-------------	------------	------------	----

Supplies information about the device profile and the device type used.

A 4.4.1.3 Object 1008h: Manufacturer's Device Name

1008	VAR	Device name	IMC5x00	Visible String	ro
------	-----	-------------	---------	----------------	----

A 4.4.1.4 Object 1009h: Hardware Version

1009	VAR	Hardware version	xx	Visible String	ro
------	-----	------------------	----	----------------	----

A 4.4.1.5 Object 100Ah: Software Version

100A	VAR	Software version	xxx.xxx	Visible String	ro
------	-----	------------------	---------	----------------	----

A 4.4.1.6 Object 1018h: Device Identification

1018	RECORD	Identity			
------	--------	----------	--	--	--

Sub-indices

0	VAR	Number of entries	4	Unsigned8	ro
1	VAR	Vendor ID	0x00000607	Unsigned32	ro
2	VAR	Product code	0x0024E555	Unsigned32	ro
3	VAR	Revision	0x00010000	Unsigned32	ro
4	VAR	Serial number	0x009A4435	Unsigned32	ro

The article number is defined in the `product code`, the serial number of the controller is defined in the `serial number`.

A 4.4.1.7 TxPDO Mapping

1A00	01Peak1 TxPDOMap			
	01Peak1 0x6000			
1AB0	Shutter TxPDOMap			
	CH01SHUTTER 0x6030			
1AC0	Encoder1 und Encoder2 TxPDOMap			
	ENCODER1 0x6050	ENCODER2 0x6051		
1AD0	Encoder3 TxPDOMap			
	Encoder3 0x6052			
1AE0	Counter TxPDOMap			
	COUNTER 0x7000			
1AE8	States TxPDOMap			
	TIMESTAMP 0x7001			
1AF0	Measrate TxPDOMap			
	MEASRATE 0x7002			
1AF8	State TxPDOMap			
	State 0x7003			
1B00	UserCalc01 TxPDOMap			
	UserCalcOutput01 0x7C00			
1B08	UserCalc02 TxPDOMap			
	UserCalcOutput02 0x7C01			
1B10	UserCalc03 TxPDOMap			
	UserCalcOutput03 0x7C02			
1B18	UserCalc04 TxPDOMap			
	UserCalcOutput04 0x7C03			
1B20	UserCalc05 and 06 TxPDOMap			
	UserCalcOutput05 0x7C04	UserCalcOutput06 0x7C05		
...	...			
		
1B58	UserCalc19 and 20 TxPDOMap			
	UserCalcOutput 19 0x7C12	UserCalcOutput20 0x7C13		
1B60	UserCalc21 to 24 TxPDOMap			
	UserCalcOutput21 0x7C14	UserCalcOutput22 0x7C15	UserCalcOutput23 0x7C16	UserCalcOutput24 0x7C17
...	...			

1BA8	UserCalc57 to 60 TxPDOMap			
	UserCalcOutput57 0x7C38	UserCalcOutput58 0x7C39	UserCalcOutput59 0x7C3A	UserCalcOutput60 0x7C3B

Fig. 83 PDO mapping objects

In object 0x1C13 is selected which PDOs are transferred. The PDO mapping objects are selected. The selection process takes place before switching from PreOP to SafeOP mode.

Example 1: Startup procedure to output thickness 1 from channel 1 (01PEAK01):

- Thickness 1 is expressed in 0x6000. In order to transfer 0x6000 in the PDO, the PDO mapping object 0x1A00 must be selected in 0x1C13.

Object	Value	Description
0x1C13:00	0x00 (0)	clear sm pdos (0x1C13)
0x1C13:01	0x1A00 (6656)	download pdo 0x1C13:01 index
0x1C13:00	0x01 (1)	download pdo 0x1C13 count

Example 2: Startup procedure to output thickness 1, signal quality 1, shutter speed, encoder 1 and encoder 2 from channel 1 (01PEAK01, 01SHUTTER, 01ENCODER1, 01ENCODER2).

- Thickness 1 is expressed in 0x6000. In order to transfer 0x6000 in the PDO, the PDO mapping object 0x1A00 must be selected in 0x1C13.
- Signal quality 1 is expressed in 0x6010. In order to transfer 0x6010 in the PDO, the PDO mapping object 0x1A30 must be selected in 0x1C13.
- The shutter speed is expressed in 0x6010, encoder 1 in 0x6050 and encoder 2 in 0x6051. The four process data are merged in 0x1A70 and must be selected in 0x1C13 for transfer in the PDO.

Object	Value	Description
0x1C13:00	0x00 (0)	clear sm pdos (0x1C13)
0x1C13:01	0x1A00 (6656)	download pdo 0x1C13:01 index
0x1C13:02	0x1A70 (6768)	download pdo 0x1C13:03 index
0x1C13:00	0x02 (2)	download pdo 0x1C13 count

A 4.4.1.8 Object 1C00h: Type of Synchronization Manager

1C00	RECORD	Sync manager type			ro
------	--------	-------------------	--	--	----

Sub-indices

0	VAR	Number of entries	4	Unsigned8	ro
1	VAR	Sync manager 1	0x01	Unsigned8	ro
2	VAR	Sync manager 2	0x02	Unsigned8	ro
3	VAR	Sync manager 3	0x03	Unsigned8	ro
4	VAR	Sync manager 4	0x04	Unsigned8	ro

A 4.4.1.9 Object 1C12h: RxPDO Assign

1C12	ARRAY	RxPDO-Assign			rw
------	-------	--------------	--	--	----

Sub-indices

0	VAR	Number of entries	0	Unsigned8	ro
---	-----	-------------------	---	-----------	----

No RxPDOs can be selected because none are present. The object is implemented as a dummy to enable the EtherCAT master to set the RxPDOs to 0.

A 4.4.1.10 Object 1C13h: TxPDO Assign

1C13	ARRAY	TxPDO-Assign			rw
------	-------	--------------	--	--	----

Sub-indices

0	VAR	Number of entries	n	Unsigned8	rw
1	VAR	Sub-index 001	0x1A00	Unsigned16	rw
2	VAR	Sub-index 002		Unsigned16	rw
..					
n	VAR	Sub-index n	-	Unsigned16	rw

Object for selecting the PDOs (TxPDO maps), see [Chap. A 4.3.7](#).

A 4.4.1.11 Object 1C33h: Synchronization Manager Input Parameters

1C33	RECORD	SM input parameter			ro
Sub-indices					
0	VAR	Number of entries	9	Unsigned8	ro
1	VAR	Synchronization type	x	Unsigned16	ro
2	VAR	Cycle time	x	Unsigned32	ro
4	VAR	Supported synchronization types	0x4005	Unsigned16	ro
5	VAR	Minimum cycle time	1000000	Unsigned32	ro
6	VAR	Calc and copy time	x	Unsigned32	ro
8	VAR	Get cycle time	x	Unsigned16	rw
9	VAR	Delay time		Unsigned32	ro
12	VAR	Cycle Time Too Small		Unsigned16	ro

- Synchronization Type: currently specified synchronization
 - 0: Freerun,
 - 2: Distributed clock Sync0 synchronization, see [Chap. A 4.9.2](#)
- Cycle Time: currently specified cycle time in ns
 - Free run, the cycle time derived from the measuring rate,
 - Sync0 synchronization, the Sync0 cycle time set by the master.

The minimum cycle time is derived from the maximum measuring rate and equals 153.846 μ s.

- Supported synchronization types: Free run and Sync0 synchronization are supported
- Calc and Copy Time, Get Cycle Time: If “Get Cycle Time” is set to 1, the Calc and Copy time is measured and displayed in the entry of the same name (only for Sync0 synchronization)
- Delay time: SYNC0 pulse triggers the sampling; therefore this value is always 0.

A 4.4.2 Manufacturer-Specific Objects

A 4.4.2.1 Overview

Index (h)	Name	Description
2001	User level	Login, logout, change password
2005	Controller information	Controller info (continued)
2020	Basicsettings	Load, save, factory settings
2021	Preset	Signal quality
2022	Meas. settings	Measurement settings
203F	Sensor error	Sensor error
2101	Reset	Restart controller
2105	Factory reset	Reset to factory settings
2107	Counter reset	Reset counter
2133	SLED on/off	Switch on/off light source
2134	Pilotlaser on/off	Switch on/off pilot laser
2141	Video signal	Request FFT signal
2142	Video signal enable	Share FFT signal
2150	Sensor	Sensor information
2152	Select sensor	Select sensor
2156	Multilayer options	Number of peaks for multilayer materials
2161	Peak position	Peak selection
21B0	Digital interfaces	Digital interfaces
21B1	Enable output	Select interface
21C0	Ethernet	Ethernet, IP configuration
21D0	Analog output	Analog output, scaling
21F3	Switching output 1	Switching output 1/2
21F4	Switching output 2	
2250	Shutter mode	Exposure mode
2251	Measuring rate	Measuring rate
24A0	Keylock	Locks the mult-function button on the controller
24A2	Keyfunc	Functionality of the multi-function button
25A0	Encoder	
2711	Range of interest	Masks the evaluation range
2800	Material info and edit	Material information
2802	Material table edit	Edit material table
2803	Material table	Existing materials in the material table
2804	Material selection	Select material
2805	Material infront	Material between sensor and first layer
2A00-2A09	Master y	Master value, mastering
2A10-2A19	Statistic	Statistics
2C00-2C09	Comp y	Measured value calculation
2E00	User calc	User signals

- Invalid entries when reading and writing manufacturer-specific objects can result in errors. These errors are described in the SDO abort codes, see [Chap. A 4.6](#).
If an error occurs while writing a value, you may be able to retrieve error details in object 203F.

A 4.4.2.2 Object 2001h: User Level

2001	RECORD	User level			
------	--------	------------	--	--	--

Sub-indices

0	VAR	Number of entries	7	Unsigned8	ro
1	VAR	Actual user	x	Unsigned8	ro
2	VAR	Login		Visible string	wo
3	VAR	Logout	FALSE	BOOL	rw
4	VAR	Default user	x	Unsigned8	rw
5	VAR	Password old		Visible string	wo
6	VAR	Password new		Visible string	wo
7	VAR	Password repeat		Visible string	wo

For more information, please refer to the Login section, see [Chap. 7.6.5](#), and the User Level section, see [Chap. A 3.3.2](#).

Actual user, Default user:

0 - Operator

1 - Expert

Modifying the user level will change the access rights for objects. Once you `log out`, RW objects change to read-only (= ro), and write-only objects (= wo) are no longer available.

To change the password, you need to complete the three passwords fields (Old, New and Repeat) in this particular order. The maximum password length is 31 characters.

A 4.4.2.3 Object 2005h: Controller Info (continued)

2005	RECORD	Controller Info			ro
------	--------	-----------------	--	--	----

Sub-indices

0	VAR	Number of entries	8	Unsigned8	ro
1	VAR	Name	IMS5x00	Visible String	ro
5	VAR	Serial No	xxxxxxx	Visible String	ro
6	VAR	Option No	xxx	Visible String	ro
8	VAR	Article No	xxxxxxx	Visible String	ro

For more information, please refer to the Controller Information section, see [Chap. A 3.3.1.2](#).

A 4.4.2.4 Objekt 2020h: Load, Save, Factory Settings

2020	RECORD	Basic settings			ro
------	--------	----------------	--	--	----

Sub-indices

0	VAR	Number of entries	3	Unsigned8	ro
1	VAR	READ		BOOL	wo
2	VAR	STORE		BOOL	wo
3	VAR	SETDEFAULT		BOOL	wo

- READ: Loads the last saved basic settings
- STORE: Stores the current settings
- SETDEFAULT: Resets the basic settings to factory defaults

A 4.4.2.5 Objekt 2021h: Preset

2021	RECORD	Preset			ro
------	--------	--------	--	--	----

Sub-indices

0	VAR	Number of entries	3	Unsigned8	ro
1	VAR	Mode	x	Unsigned8	rw
2	VAR	List		Visual string	ro
3	VAR	Named read		Visual string	wo

Mode:

- 0 – STATIC
- 1 – BALANCED
- 2 – DYNAMIC

For more information, please refer to the Measurement Settings section, see [Chap. A 4.4.2.6](#).

A 4.4.2.6 Objekt 2022h: Measurement Settings

2022	RECORD	Meassettings			ro
------	--------	--------------	--	--	----

Sub-indices

0	VAR	Number of entries	7	Unsigned8	
1	VAR	Current		Visual string	ro
2	VAR	Named read		Visual string	wo
3	VAR	Named store		Visual string	wo
4	VAR	Named delete		Visual string	wo
5	VAR	Initial meassettings		Visual string	rw
6	VAR	List		Visual string	ro
7	VAR	Set default		BOOL	wo

- Current: Current measurement settings (`MEASSETTINGS CURRENT`)
- Named read: Loads a measurement setting from the `list/sub-index 6` (`MEASSETTINGS READ`)
- Named store: Stores the current measurement setting. You can assign a name or number (`MEASSETTINGS STORE`)
- Named delete: Deletes a measurement setting from the `list/sub-index 6` (`MEASSETTINGS DELETE`)
- Initial meas. settings: Measurement setting that is initially loaded during a controller reset (`MEASSETTINGS INITIAL`)
- List: List with stored measurement settings (`MEASSETTINGS LIST`)
- Set default: Corresponds to the `SETDEFAULT MEASSETTINGS` command

For more information, please refer to the Measurement Settings, see [Chap. A 3.3.7.6](#).

A 4.4.2.7 Object 203Fh: Sensor Error

203F	RECORD	Sensor error			ro
------	--------	--------------	--	--	----

Sub-indices

0	VAR	Number of entries	2	Unsigned8	ro
1	VAR	Sensor error number	x	Unsigned16	ro
2	VAR	Sensor error description	x	Visible String	ro

For more information, please refer to the Error Messages section.

- Sensor error number: Outputs the sensor error during communication
- Sensor error description: Sensor error as plain text

A 4.4.2.8 Object 2101h: Reset

2101	VAR	Reset	FALSE	BOOL	rw
------	-----	-------	-------	------	----

Restarts the controller.

A 4.4.2.9 Object 2105h: Factory Settings

2105	VAR	Factory reset		BOOL	wo
------	-----	---------------	--	------	----

Reset to factory defaults. Corresponds to the `SETDEFAULT ALL` command.

A 4.4.2.10 Object 2107h: Reset Counter

2107	RECORD	Counter reset			ro
Sub-indices					
0	VAR	Number of entries	2	Unsigned8	ro
1	VAR	Reset timestamp		BOOL	wo
2	VAR	Reset counter		BOOL	wo

Setting sub-index 1 to 1 will reset the time stamp (0x7001).

Setting sub-index 2 to 1 will reset the measured value counter (0x7000).

A 4.4.2.11 Object 2133h: SLED Light Source

2133	VAR	SLED on/off		BOOL	rw
------	-----	-------------	--	------	----

Permits switching the SLED light source on or off and is equivalent to the ASCII `SLED` command.

A 4.4.2.12 Object 2134h: Pilot Laser

2134	VAR	Pilot laser on/off		BOOL	rw
------	-----	--------------------	--	------	----

Permits switching the pilot laser on or off and is equivalent to the ASCII `PILOTLASER` command.

A 4.4.2.13 Object 2141h: Request FFT Signal

2141	RECORD	Video signal			ro
Sub-indices					
0	VAR	Number of entries	1	Unsigned8	ro
2	VAR	New frame request		BOOL	wo

If output of an FFT signal is enabled, a new image can be triggered by using this entry.

A 4.4.2.14 Object 2142h: Share FFT Signal

2142	RECORD	Video signal enable			ro
Sub-indices					
0	VAR	Number of entries	1	Unsigned8	ro
1	VAR	Enable signal		BOOL	rw

Permits output of the FFT signal.

A 4.4.2.15 Object 2150h: Sensor

2150	RECORD	Sensor			ro
Sub-indices					
0	VAR	Number of entries	3	Unsigned8	ro
1	VAR	Sensor info	IMS5x00	Visible String	ro
2	VAR	Sensor range	xx.xxxxxx	FLOAT32	ro
3	VAR	Sensor serial No	xxxxxxx	Visible String	ro

For more information, please refer to the Sensor section, see [Chap. A 3.3.3](#).

A 4.4.2.16 Object 2152h: Sensor Selection

2152	RECORD	Select sensor			ro
Sub-indices					
0	VAR	Number of entries	1	Unsigned8	ro
1	VAR	Number of sensor	x	Unsigned8	rw

For more information, please refer to the Selecting a Sensor section, see [Chap. A 3.3.3](#), and Sensor Number section, see [Chap. A 3.3.3.2](#).

A 4.4.2.17 Objekt 2156h: Number of Peaks for Multilayer Materials

2156	RECORD	Multilayer options			ro
Sub-indices					
0	VAR	Number of entries	2	Unsigned8	ro
1	VAR	Peak count	x	FLOAT32	rw

- Peak count: Indicates how many peaks are to be evaluated.

A 4.4.2.18 Object 2162h: Peak Options

2162	RECORD	Peak options			ro
Sub-indices					
0	VAR	Number of entries	2	Unsigned8	ro
1	VAR	Min threshold		FLOAT32	rw

- Min threshold: Peak detection threshold, corresponds to the `MIN_THRESHOLD` command.

A 4.4.2.19 Object 2162h: Peak Selection

2163	RECORD	Peak options			ro
Sub-indices					
0	VAR	Number of entries	2	Unsigned8	ro
1	VAR	Measpeak sort		Unsigned8	rw

- `MEASPEAK_SORT [HEIGHT=0|DISTANCE=1]`
Determines the selection of the peaks: `HEIGHT` (use the highest peak), `DISTANCE` (use the first peaks).

A 4.4.2.20 Object 21B0h: Digital Interfaces

21B0	RECORD	Digital interfaces			ro
Sub-indices					
0	VAR	Number of entries	2	Unsigned8	ro
2	VAR	RS422 baud rate	x	Unsigned32	rw
3	VAR	Ethermode		Unsigned8	rw

Subindex 2 is equivalent to the `BAUDRATE` command. Only the preset baud rates can be specified: 9600, 115200, 230400, 460800, 691200, 921600, 1500000, 2000000, 3500000, 4000000.

Subindex 3 is equivalent to the `ETHERMODE` command and specifies whether the controller starts in Ethernet or EtherCAT mode. Changes only become effective after Basicsettings store and a restart.

- 0 - Ethernet
- 1 - EtherCAT

A 4.4.2.21 Object 21B1h: Select Interface

21B1	RECORD	Enable output			ro
Sub-indices					
0	VAR	Number of entries	3	Unsigned8	ro
1	VAR	RS422	x	BOOL	rw
3	VAR	Analog out		BOOL	rw
4	VAR	Switching outputs		BOOL	rw

Corresponds to the `OUTPUT` command. Parallel output of measured values via the respective interface can be switched on and off.

A 4.4.2.22 Object 21C0h: Ethernet**Objekt 21C0h: Ethernet**

21C0	RECORD	Ethernet			ro
------	--------	----------	--	--	----

Sub-indices

0	VAR	Number of entries	4	Unsigned8	ro
1	VAR	IP address	xxx.xxx.xxx.xxx	Visible String	rw
2	VAR	Subnet mask	xxx.xxx.xxx.xxx	Visible String	rw
3	VAR	Gateway	xxx.xxx.xxx.xxx	Visible String	rw
4	VAR	DHCP	FALSE	BOOL	rw

For more information, please refer to the Ethernet IP Settings section, see [Chap. A 3.3.6.1](#).

DHCP:

- 0 - Static IP address
- 1 - DHCP

A 4.4.2.23 Objekt 21D0h: Analog Output

21D0	RECORD	Analog output			ro
------	--------	---------------	--	--	----

Sub-indices

0	VAR	Number of entries	6	Unsigned8	ro
1	VAR	Analog output	x	Unsigned8	rw
2	VAR	Signal	x	Visible String	rw
3	VAR	Available signals		Visible String	ro
4	VAR	Type of scaling	x	Unsigned8	rw
5	VAR	Two-point-scaling start	x.x	FLOAT32	rw
6	VAR	Two-point-scaling end	x.x	FLOAT32	rw

For more information, please refer to the Analog Output section, see [Chap. A 3.3.14](#).

Analog output:

- 0 - voltage 0 ... 5 V
- 1 - voltage 0 ... 10 V
- 7 - current 4 ... 20 mA

- Signal: Data can only be selected in accordance with the selected measuring program.

You can, for example, select 01PEAK1. Available signals lists the available signals.

Type of scaling:

- 0 - default scaling
- 1 - two-point scaling

A 4.4.2.24 Object 21F3h: Switching Output 1

21F3	RECORD	Analog output			ro
Sub-indices					
0	VAR	Number of entries	7	Unsigned8	ro
1	VAR	Output level		Unsigned8	rw
2	VAR	Error out		Unsigned8	rw
3	VAR	Limit signal		Visible String	rw
4	VAR	Available signals		Visible String	ro
5	VAR	Lower limit value		FLOAT32	rw
6	VAR	Upper limit value		FLOAT32	rw
7	VAR	Compare to		Unsigned8	rw

For more information, please refer to the Switching Output section, see [Chap. A 3.3.13](#).

Output level:

- 0 - PNP
- 1 - NPN
- 2 - Push-pull
- 3 - Push-pull negated

Error out:

- 1 - 01ER1
- 2 - 01ER2
- 3 - 01ER12
- 4 - 02ER1
- 5 - 02ER2
- 6 - 02ER12
- 7 - 0102ER12
- 8 - ERRORLIMIT

Use `Limit signal` to select a measured value signal that will be used for the comparison.

`Available signals` contains a list of the available signals.

Compare to:

- 1 - Lower
- 2 - Upper
- 3 - Both

Object 21F4h includes the settings for switching output 2.

A 4.4.2.25 Object 2251h: Measuring Rate

2251	RECORD	Measuring rate		FLOAT32	rw
------	--------	----------------	--	---------	----

For more information, please refer to the Measuring Rate section, see [Chap. A 3.3.8.1](#).

A 4.4.2.26 Object 24A0h: Keylock

24A0	RECORD	Keylock			ro
Sub-indices					
0	VAR	Number of entries	2	Unsigned8	ro
1	VAR	Mode	0	Unsigned8	rw
2	VAR	Delay	0	Unsigned16	rw

For more information, please refer to the Keylock section, see [Chap. A 3.3.15.3](#).

Mode:

- 0 - Inactive
- 1 - Active
- 2 - Automatic mode / Active after delay

A 4.4.2.27 Object 24A2h: Multifunction Button

24A2	RECORD	Keyfunc			ro
------	--------	---------	--	--	----

Sub-indices

0	VAR	Number of entries	4	Unsigned8	ro
1	VAR	Function 1	0	Unsigned8	rw
2	VAR	Function 2	0	Unsigned8	rw

Function 1 and 2:

- 0 - Key has no function
- 2 - Mastering
- 3 - Turns the light source on/off

Sub-index 2 in the `KEYFUNC` commando corresponds to the „signal“.

When mastering via the (Function == 2) button, this entry specifies which signal is to be used for mastering.

A 4.4.2.28 Object 25A0h: Encoder

25A0	RECORD	Encoder			ro
------	--------	---------	--	--	----

Sub-indices

0	VAR	Number of entries	10	Unsigned8	ro
1	VAR	Encoder 1 reference signal	x	Unsigned8	rw
2	VAR	Encoder 1 interpolation	x	Unsigned8	rw
3	VAR	Encoder 1 initial value	x	Unsigned32	rw
4	VAR	Encoder 1 maximal value	x	Unsigned32	rw
5	VAR	Encoder 1 set value	FALSE	BOOL	wo
6	VAR	Encoder 2 reference signal	x	Unsigned8	rw
7	VAR	Encoder 2 interpolation	x	Unsigned8	rw
8	VAR	Encoder 2 initial value	x	Unsigned32	rw
9	VAR	Encoder 2 maximal value	x	Unsigned32	rw
10	VAR	Encoder 2 set value	FALSE	BOOL	wo

For more information, please refer to the Encoder Inputs section, see [Chap. 5.7.11](#), and the Encoders section, see [Chap. A 3.3.5](#).

Encoder reference signal:

- 0 - None, the encoder's reference marker has no effect
- 1 - One, specified once
- 3 - Ever, specified for all markers

Encoder interpolation:

- 1 - Single interpolation
- 2 - Dual interpolation
- 3 - Quadruple interpolation

Encoder initial value:

0 ... $2^{32}-1$

Encoder maximum value:

0 ... $2^{32}-1$

A 4.4.2.29 Object 25A1: Encoder3

Sub-indices

0	VAR	Number of entries	5	Unsigned8	ro
1	VAR	Encoder3 enable	x	Bool	rw
2	VAR	Encoder3 interpolation	x	Unsigned8	rw
3	VAR	Encoder3 initial value	x	Unsigned32	ro
4	VAR	Encoder3 maximal value	x	Unsigned32	ro
5	VAR	Encoder3 set value	False	Bool	ro

A 4.4.2.30 Object 2711h: Masking the Evaluation Range

2711	RECORD	Range of interest			
------	--------	-------------------	--	--	--

Sub-indices

0	VAR	Number of entries	2	Unsigned8	ro
1	VAR	Range of interest start	x	Unsigned16	rw
2	VAR	Range of interest end	x	Unsigned16	rw

For more information, please refer to the Masking the Evaluation Range section, see [Chap. 7.2.2](#), see [Chap. A 3.3.8.2](#).

A 4.4.2.31 Objekt 2800h: Material Information

2800	RECORD	Material info and edit			
------	--------	------------------------	--	--	--

Sub-indices

0	VAR	Number of entries	7	Unsigned8	ro
1	VAR	Material name	xxxxx	Visible String	rw
2	VAR	Material description	xxxxxx	Visible String	rw
3	VAR	group index	x.xxxx	FLOAT32	rw

For more information, please refer to the Material Database section, see [Chap. A 3.3.9](#).

- Material name: Currently selected material for a thickness measurement
- Material description: Description of the currently selected material
- group index: Refractive index of the currently selected material at 845 nm

The current material can be edited in Expert mode. Specified settings are stored immediately.

A 4.4.2.32 Object 2802h: Edit Material Table

2802	RECORD	Material table edit			
------	--------	---------------------	--	--	--

Sub-indices

0	VAR	Number of entries	4	Unsigned8	ro
1	VAR	Material delete	x	Visible String	wo
2	VAR	Reset materials	x	BOOL	wo
3	VAR	New material	x	BOOL	wo
4	VAR	Select material for edit		Visible String	wo

- Material delete: Specify the name of a material to be deleted from the material table
- Reset Materials: Resets the material table to the factory settings
- New material: Creates a new material in the material table. The newly created material („NewMaterial“) is edited in object 2800h „Material info“.

Sub-index 4 selects the material that is to be edited in object 0x2800.

A 4.4.2.33 Object 2803h: Existing Materials

2803	RECORD	Material table			
------	--------	----------------	--	--	--

Sub-indices

0	VAR	Number of entries	1	Unsigned8	ro
1	VAR	Material name list	„xx“ „xx“ ...	Visible String	ro

Provides a list of all available materials: Air calibration / Air / BK7 / D263T / Ethanol / Fused Silica / LaSF9 / Mirror / N-SF6 / PC / PMMA / PS / Vacuum.

A 4.4.2.34 Object 2804h: Select Material

2804	RECORD	Material selection			
------	--------	--------------------	--	--	--

Sub-indices

0	VAR	Number of entries	5	Unsigned8	ro
1	VAR	Material 1	xx	Visible String	rw
...					
E	VAR	Material	xx	Visible String	rw

Specification of the material whose characteristics are included in the measured values

The selected material must be present in the materials table.

A 4.4.2.35 Objekt 2805h: Material between Sensor and 1st Layer

2805	RECORD	Material in front			
------	--------	-------------------	--	--	--

Sub-indices

0	VAR	Number of entries	1	Unsigned8	ro
1	VAR	Material	xx	Visible String	rw

Indication of the material located between the sensor front face and the first layer of the target.

A 4.4.2.36 Object 2A00h: Mastering

2A00	RECORD	Master 1			
------	--------	----------	--	--	--

Sub-indices

0	VAR	Number of entries	5	Unsigned8	ro
1	VAR	Enable	xx	BOOL	rw
2	VAR	Signal	xx	Visible String	rw
3	VAR	Available signals	xx	Visible String	ro
4	VAR	Set/reset	xx	BOOL	rw
5	VAR	Value	xx	FLOAT32	rw

Masters or sets to zero a signal; there are 10 such objects (2A00h to 2A09h). References the `MASTERSIGNAL` command. The sub-index specifies which signal is to be mastered. Sub-index 3 corresponds to the `META_MASTERSIGNAL` command.

Sub-index 4 corresponds to the `MASTER` command.

A 4.4.2.37 Object 2A10h: Statistics

2A10	RECORD	Statistic 1			
------	--------	-------------	--	--	--

Sub-indices

0	VAR	Number of entries	6	Unsigned8	ro
1	VAR	Enable		BOOL	rw
2	VAR	Signal		Visible String	rw
3	VAR	Available signals		Visible String	ro
4	VAR	Infinite		BOOL	rw
5	VAR	Depth		Unsigned32	rw
6	VAR	Reset		BOOL	rw

The objects 2A10h to 2A19h generate 10 statistics signals.

Sub-index 3 corresponds to the `META_STATISTICSIGNAL` command.

Sub-index 6 corresponds to the `STATISTIC` command.

3 signals are generated for each activated statistics object. These signals are listed in object 0x2E00. The statistics function can also be applied to user signals.

Example: You want thickness 1 (channel 1) to output the minimum and the maximum measured values using all previous thickness values.

- Activating a statistics object
2A10:01(Enable) to TRUE. Thickness 1 (01PEAK1) is selected as signal by default. If you would like to display statistics for a different signal, you will need to select the required signal in sub-index 2.
- Settings for all previous thickness values
2A10:04 (Infinite) to True (`STATISTICSIGNAL – INFINITE`)

Associating a user-defined signal with the PDO

The newly generated signal names appear in object 0x2E00h:

2E00:0	User calc	RO	> 60 <		
2E00:01	User calc 01	RO	01DIST1_MIN	+	7C00:0
2E00:02	User calc 02	RO	01DIST1_PEAK	+	7C01:0
2E00:03	User calc 03	RO	01DIST1_MAX	+	7C02:0
2E00:04	User calc 04	RO		+	7C03:0
2E00:05	User calc 05	RO		+	7C04:0
2E00:06	User calc 06	RO		+	7C05:0
2E00:07	User calc 07	RO		+	7C06:0
2E00:08	User calc 08	RO		+	7C07:0
2E00:09	User calc 09	RO		+	7C08:0
2E00:0A	User calc 10	RO		+	7C09:0

The minimum thickness is output in 0x7C00h and the maximum thickness is output in 0x7C02h.

Select PDO

UserCalcOutput01 – 0x7C00h is selected with object 1B00h, and 0x7C02h is output with object 1B10h.

1B00	UserCalc01 TxPDOMap	
	UserCalcOutput01	0x7C00
1B08	UserCalc02 TxPDOMap	
	UserCalcOutput02	0x7C01
1B10	UserCalc03 TxPDOMap	
	UserCalcOutput03	0x7C02

Extract with TxPDO Mapping, see [Chap. A 4.4.1.7](#).

Therefore, the following selections need to be made in 0x1C13h, 0x1B00h and 0x1B10h before PreOp is switched to SafeOp:

0x00 (0)1B00	clear sm pdos (0x1C13)
0x1B00 (6912)	download pdo 0x1C13:01 index
0x1B10 (6928)	download pdo 0x1C13:02 index
0x02 (2)	download pdo 0x1C13 count

A 4.4.2.38 Object 2C00h: Measured Value Calculation

2C00	RECORD	Comp y			
Sub-indices					
0	VAR	Number of entries	8	Unsigned8	ro
1	VAR	Type		Unsigned16	rw
2	VAR	Name1		Visible String	rw
4	VAR	Signal1		Visible String	rw
5	VAR	Signal2		Visible String	rw
12	VAR	Available signals		Visible String	ro
13	VAR	Factor1		FLOAT32	rw
14	VAR	Factor2		FLOAT32	rw
17	VAR	Offset		Integer32	rw
18	VAR	Param1		Unsigned32	rw

Objects 2C00h to 2C09h include 10 calculation modules.

Type:

- 0 - None
- 1 - Moving average (MOVING)
- 2 - Recursive average (RECURSIVE)
- 3 - Median (MEDIAN)
- 4 - Calculation (CALC)
- 8 - Thickness calculation (THICKNESS)
- 9 - Copy

As soon as the type is changed, default settings are loaded for the selected type. You can only select signals from the corresponding channel.

Depending on the type, all other object entries have different meanings:

- Moving average (MOVING):

4	Signal1	Signal to which the filter will be applied (default 01PEAK1)
18	Param1	Averaging number (default 2)

Value range for Param1: 2|4|8|16|32|64|128|256|512|1024|2048|4096

- Recursive average (RECURSIVE):

4	Signal1	Signal to which the filter will be applied (default 01PEAK1)
18	Param1	Averaging number (default 2)

Value range for Param1: 2 ... 32000

- Median (MEDIAN)

4	Signal1	Signal to which the filter will be applied (default 01PEAK1)
18	Param1	Averaging number (default 3)

Value range for Param1: 3|5|7|9

- Calculation (CALC), consisting of two addends (signal), sign/scaling (factor) and a constant (offset);

formula: $CALC = (<factor1> * <signal1>) + (<factor2> * <signal2>) + <offset>$

The result of the calculation is written to a new variable <name>.

4, 5	Signal1 Signal2	Signal to be used for the calculation
13, 14	Factor1 Factor2	Value range -32768.0 .. 32767.0 (unit mm)
17	Offset	Value range -21.47 .. 21.47 (unit mm)
2	Name	Name of calculation block; length min. 2 characters, max. 15 characters. Permitted characters a-zA-Z0-9, the name must start with a letter. Command names – e.g. STATISTIC, MASTER, NONE, ALL – are not permitted.

- **THICKNESS**: Thickness calculation (difference) from two peaks;
formula: $THICKNESS = \langle signal1 \rangle - \langle signal2 \rangle$
The result of the calculation is written to a new variable $\langle name \rangle$.

4, 5	Signal1 Signal2	Signal to be used for the thicknesses calculation; $signal1 > signal2$
2	Name	<i>Name of calculation block; length min. 2 characters, max. 15 characters. Permitted characters a-zA-Z0-9, the name must start with a letter. Command names – e.g. STATISTIC, MASTER, NONE, ALL – are not permitted.</i>

- **COPY**: Duplicates a signal
- **NONE**: deletes a calculation block

Subindex 12 `Available signals` lists the possible signals for the measured value calculation.

i The object index determines the processing sequence and corresponds to the `ID` parameter for the ASCII command.

Example: Signal 01PEAK1 is to be filtered using a median filter and an average value filter. The sequence is first median filter, then average value filter.

0x2C00:

1	Type	3 (Median)
4	Signal1	01PEAK1
18	Param1	<Averaging number>

0x2C01:

1	Type	2 (Recursive average)
4	Signal1	01PEAK1
18	Param1	<Averaging number>

Filters can also be applied to user signals.

A 4.4.2.39 Object 2E00: User Signals

2E00	RECORD	User calc			
------	--------	-----------	--	--	--

Sub-indices

0	VAR	Number of entries	60	Unsigned8	ro
1	VAR	User calc 01		Visible String	ro
2	VAR	User calc 02		Visible String	ro
...					
3C	VAR	User calc 60		Visible String	ro

Names of the user signals that are output in the 0x7C0xh objects. The sequence specifies the order of the PDO data. The PDOs are selected via the 0x1B0xh objects.

A 4.5 Mappable objects – process data

Displays all individually available process data.

The objects 0x600x, 0x680x, 0x700x and 0x7C0x are structured as follows:

[INDEX]		[NAME]			
	0	Sub-index 0	Uint8	READ	1 (fix)
	1	Sub-index 1	[DATA TYPE]	READ	-

Objects 0x6000: Process data.

Objects 0x7000: System process data (process data that are not available per channel).

Objects 0x7C00: Calculated process data.

The names of the objects are based on the names of potential parameters for the `OUT_ETH` command.

I The process data for the objects are not yet available after switching on. Only a successful state change from PreOP to SafeOP makes the process data available which were selected through object 0x1C13h or the mapping objects for the PDO output. If the state changes from SafeOP to OP, all previously selected process data are still available.

INDEX	NAME	Data type/ range	Scaling	Unit
6000	01PEAK1 (thickness value)	INT32 -2 ³²⁻¹ ... +2 ³²⁻¹	10	pm
6030	SHUTTER	UINT32 10 ... 100000	value / 10	μs
6050	ENCODER1	UINT32 0 ... 2 ³²⁻¹	-	Ticks
6051	ENCODER2	UINT32 0 ... 2 ³²⁻¹	-	Ticks
6052	ENCODER3	UINT32 0 ... 2 ³²⁻¹	-	Ticks
7000	COUNTER	UINT32 0 ... 2 ³²⁻¹		
7001	TIMESTAMP	UINT32 0 ... 2 ³²⁻¹	value / 1000000	s
7002	FREQUENCY	UINT32 1538 ... 100000	10*1000 / value	kHz
7C00	UserCalcOutput01	INT32 -2 ³²⁻¹ ... +2 ³²⁻¹	10	pm
7C01	UserCalcOutput02	INT32 -2 ³²⁻¹ ... +2 ³²⁻¹	10	pm
...		
7C3B	UserCalcOutput60	INT32 -2 ³²⁻¹ ... +2 ³²⁻¹	10	pm

Fig. 84 Mappable Objects

A 4.6 Error codes for SDO services

If an SDO requirement is evaluated as negative, a corresponding error code is added to the “Abort SDO Transfer Protocol”.

Hexadecimal error code	Meaning
0503 0000	Toggle bit did not change
0504 0000	SDO protocol timeout expired
0504 0001	Invalid command entered
0504 0005	Insufficient memory
0601 0000	Access to object (parameter) not supported
0601 0001	Attempt to read a “write-only parameter”
0601 0002	Attempt to write a “read-only parameter”
0602 0000	Object (parameter) is not listed in the object directory
0604 0041	Object (parameter) cannot be mapped to PDO
0604 0042	Number or length of the transfer objects exceeds the PDO length
0604 0043	General parameter incompatibility
0604 0047	General internal device incompatibility
0606 0000	Access denied due to a hardware error
0607 0010	Incorrect data type or length of the service parameter does not match
0607 0012	Incorrect data type or the service parameter is too long
0607 0013	Incorrect data type or the service parameter is too short
0609 0011	Sub-index does not exist
0609 0030	Invalid value for the parameter (only for write access)
0609 0031	Value of parameter too high
0609 0032	Value of parameter too low
0609 0036	Maximum value is below minimum value.
0800 0000	General error
0800 0020	Unable to transfer data to the application or unable to store data
0800 0021	Unable to transfer data to the application or unable to store data. Cause: local control
0800 0022	Unable to transfer data to the application or unable to store data. Cause: device state
0800 0023	Dynamic generation of the object directory failed or no object directory available

A 4.7 Oversampling

In operation without oversampling, the last acquired data record containing measured values is transmitted to the EtherCAT Master with each fieldbus cycle, see [Chap. A 4.4.1.7](#). Therefore, for long fieldbus cycle periods many data records with measured values are not available. Configurable oversampling ensures that all (or selected) measured value data records are gathered and transmitted together to the master during the next fieldbus cycle.

The oversampling factor specifies how many samples per bus cycle are transmitted. For example, an oversampling factor of 2 means that 2 samples are transferred per bus cycle.

With TxPDO Mapping, see [Fig. 83](#), the base index of the PDO mapping objects is included with the oversampling factor 1.

Use the following list to determine the index for selecting a different oversampling factor:

- Base index + 1: Oversampling factor 2
- Base index + 2: Oversampling factor 4
- Base index + 3: Oversampling factor 8

You can only select mapping objects with the same oversampling factor in 0x1C13h.

Example:

- The fieldbus/EtherCAT master operates at a cycle time of 1 ms because the higher-level PLC works with a cycle time of 1 ms. This means that every 1 ms, an EtherCAT frame is sent to the interferoMETER to pick up process data. If the measuring frequency is set to 4 kHz, you need to specify an oversampling of 4.
- Startup procedure to output thickness 1 (01PEAK1) with an oversampling factor of 4.
 - Set the object Peak count 2156:01h to 1 to obtain a thickness.
 - Thickness 1 is output in object 6000h. In order to transfer this object in the PDO, the PDO mapping object 0x1A00 must be selected in object 0x1C13:01h. However, 0x1A02 (base index 0x1A00 + 2) must be selected for the 4-fold oversampling.

1A01:0	Ch01Dist1 TxPDOMap OV2	RO	> 2 <
1A02:0	Ch01Dist1 TxPDOMap OV4	RO	> 4 <
1A02:01	Subindex 001	RO	0x6000:01, 32
1A02:02	Subindex 002	RO	0x6000:01, 32
1A02:03	Subindex 003	RO	0x6000:01, 32
1A02:04	Subindex 004	RO	0x6000:01, 32
1A03:0	Ch01Dist1 TxPDOMap OV8	RO	> 8 <

To ensure that no samples are lost due to the asynchronous nature between the master cycle and slave cycle, the master cycle time should always be less than the time for building a block from n samples.

An entire block with the specified samples is only made available to the EtherCAT side after all specified samples have been written to the block. If the time for filling a block is less than the master cycle time, individual blocks are not transferred. It can indeed happen that the next block is already being filled with samples before the previously filled block is picked up in a master cycle.

Time for n samples < master cycle time

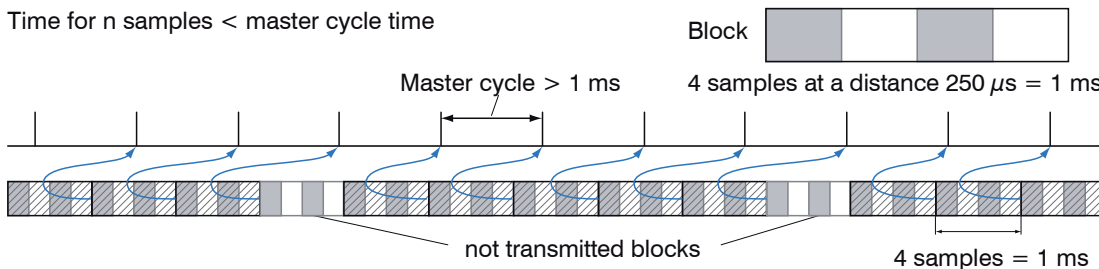

But if you select a number of samples sufficiently large so that the time for filling a block is greater than the master cycle time, each block will be picked up in a master cycle. Individual blocks (and therefore samples), however, will be transferred two or more times. This can be detected on the master side by transferring the timestamp or value counter (see object 0x21B0).

Time for n samples > master cycle time

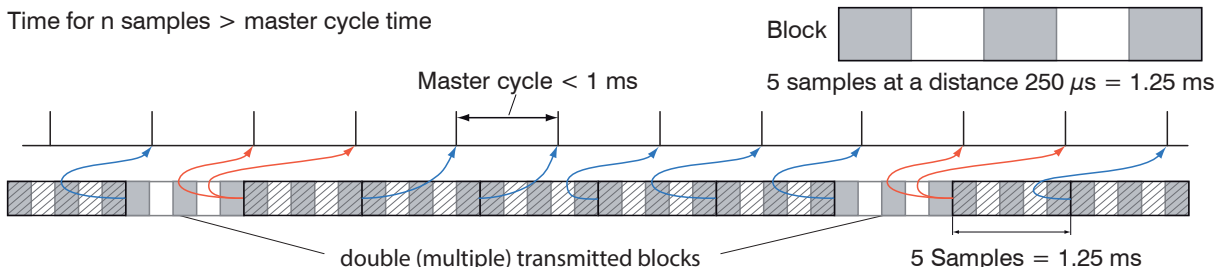

A 4.8 Calculation

Setting a filter or a function, see [A 4.4.2.39](#).

A 4.9 Operational Modes

A 4.9.1 Free Run

There is no synchronization. The PDOs are updated in line with the internal measuring rate. The measuring rate is set using object 0x2251h.

Use the measured value counter in 0x7000h or 0x1AE0h to ensure that no measured values are evaluated twice due to the lack of synchronization.

A 4.9.2 Distributed Clocks SYNC0 Synchronization

The measuring rate is determined by the SYNC0 cycle time. In this mode, an EtherCAT master can synchronize the measured value acquisition for the EtherCAT cycle time and the measured value acquisition for multiple controllers.

The ESI-XML file includes predefined SYNC0 cycle times.

But you can set any cycle time between 153846 ns (measuring rate = 6.5 kHz) and 10,000,000 ns (measuring rate = 0.1 kHz).

A 4.10 FFT Signal via SDO

The output of the FFT signal is activated via object 0x2142:1h.

Every time a FFT image is triggered via object 0x2141:2h, objects 0x8000h and 0x8800 store the new image data. The data are provided as 1024-byte octet strings. On the side of the EtherCAT master, the data need to be interpreted as vector of 16-bit unsigned integers.

The output of the FFT signal can be parallel to the PDO output of process data. The process data in objects 0x6000h to 0x7FFFh will no longer be updated cyclically once a FFT signal has been activated. Instead, updates will be triggered by FFT images. This ensures that each FFT image can be associated with the thickness value that is calculated for this image.

A 4.11 STATUS LEDs in EtherCAT Operation

STATUS-LED

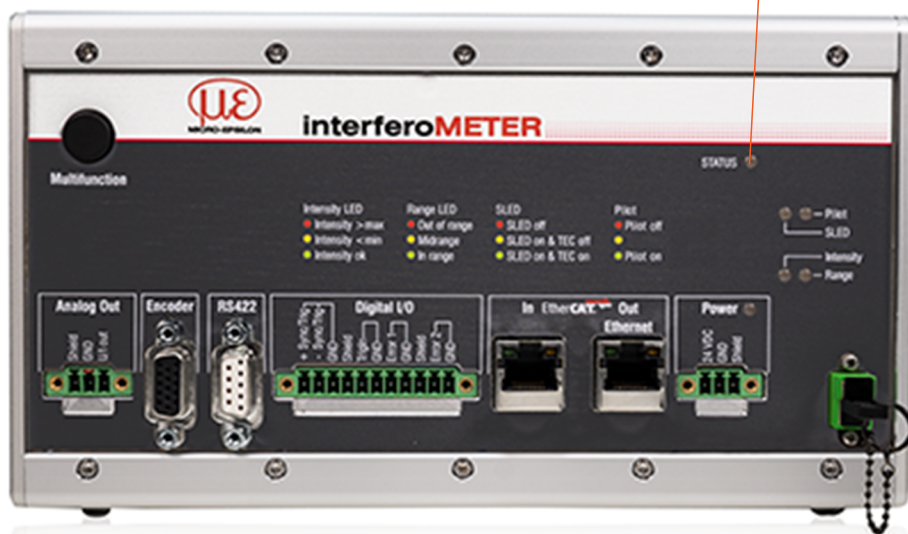

Status LED	Green state:	
	Green off	INIT state
	Green flashing 2.5 Hz	PRE-OP state
	Green single flash, 200 ms ON / 1000 ms OFF	SAFE-OP state
	Green on	OP state
	Red faults (displayed while green LED pauses):	
	Red off	No fault
	Red flashing 2.5 Hz	Invalid configuration
	Red single flash, 200 ms ON / 1000 ms OFF	Unrequested change of state
	Red double flash, 200 ms ON / 200 ms OFF 200 ms ON 400 ms OFF	Watchdog timeout
	Red flashing 10 Hz	Error during initialization

A 4.12 EtherCAT Configuration with the Beckhoff TwinCAT® Manager

An example for an EtherCAT master on the PC is the Beckhoff TwinCAT Manager.

Before you can use EtherCAT for the controller, the controller must be configured for EtherCAT operation, see [A 4.2](#).

➤ Copy the device description file (EtherCAT® Slave Information) `IMC540x.xml` to the `TwinCAT\3.1\Config\Io\EtherCAT` directory before the measuring device can be configured using EtherCAT®.

IMS5420-TH24 <Micro-Epsilon_interferometer_5420.xml>

IMS5420MP-TH24 <Micro-Epsilon_interferometer_5x00MP.xml>

➤ Delete any older files that may exist.

EtherCAT® slave information files are XML files that specify the properties of the slave device for the EtherCAT® master. They contain information about the supported communication objects.

➤ Restart the TwinCAT manager after the copy operation.

Searching for a device:

➤ Select the `I/O Devices` tab and then select `Scan`.

➤ Confirm with `OK`.

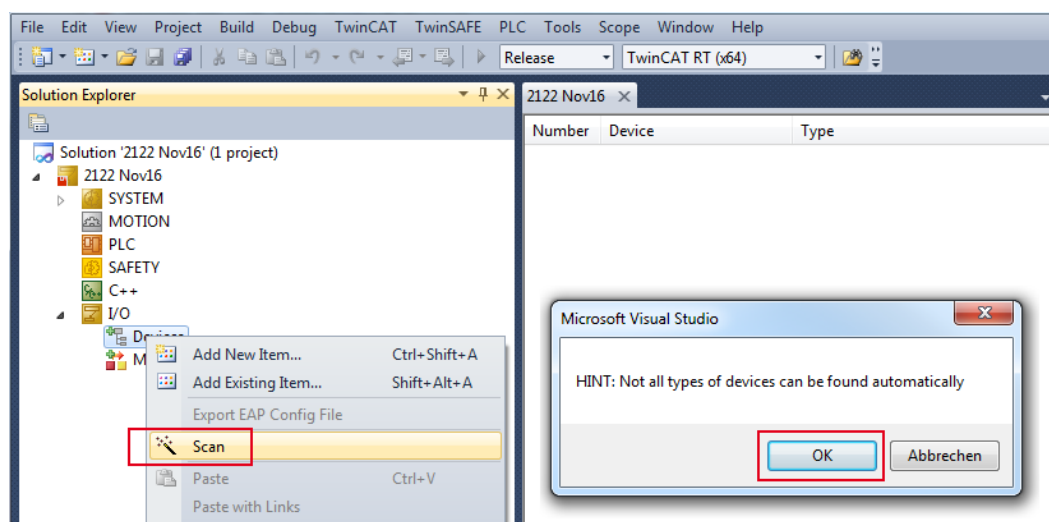

➤ Select a network card which will be searched for EtherCAT® slaves.

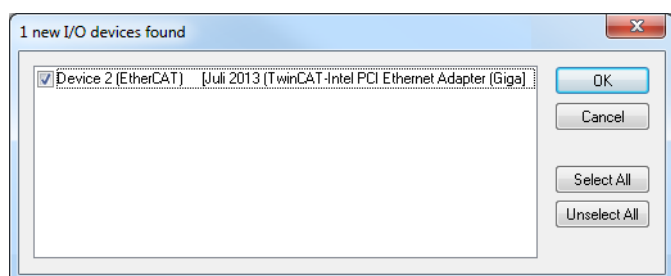

➤ Confirm with `OK`.

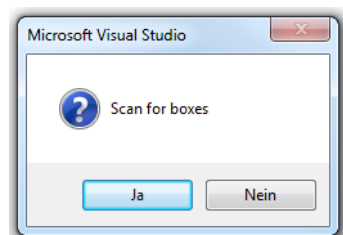

The „Scan for boxes“ window appears (EtherCAT®-Slaves).

➤ Confirm with `Yes`.

The interferometer is now included in a list.

➡ Acknowledge the Activate Free Run with Yes.

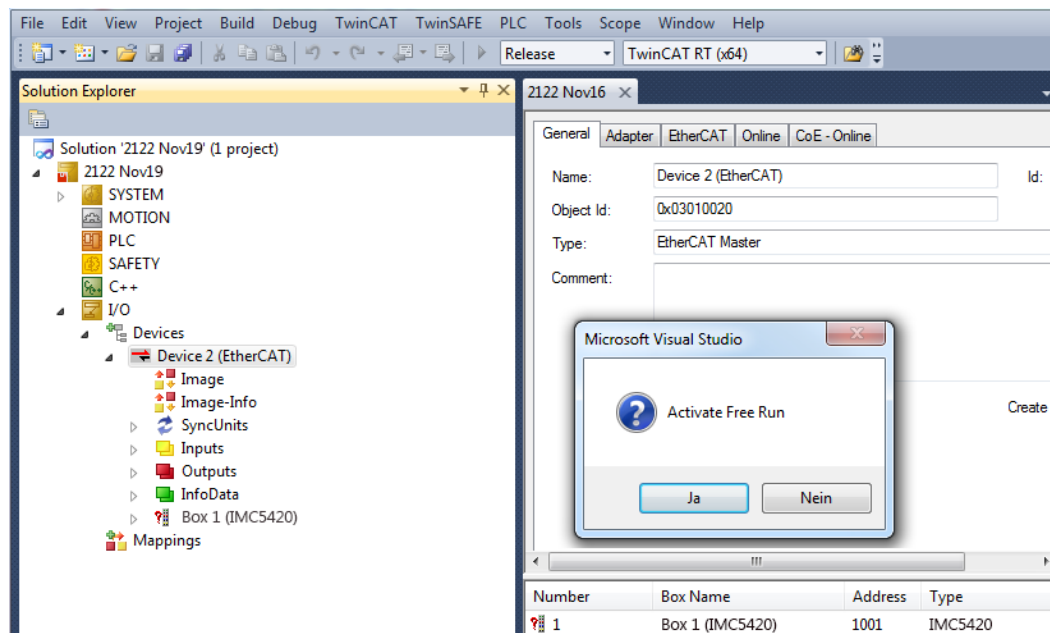

The current status on the online side should at least indicate PREOP, SAFEOP or OP.

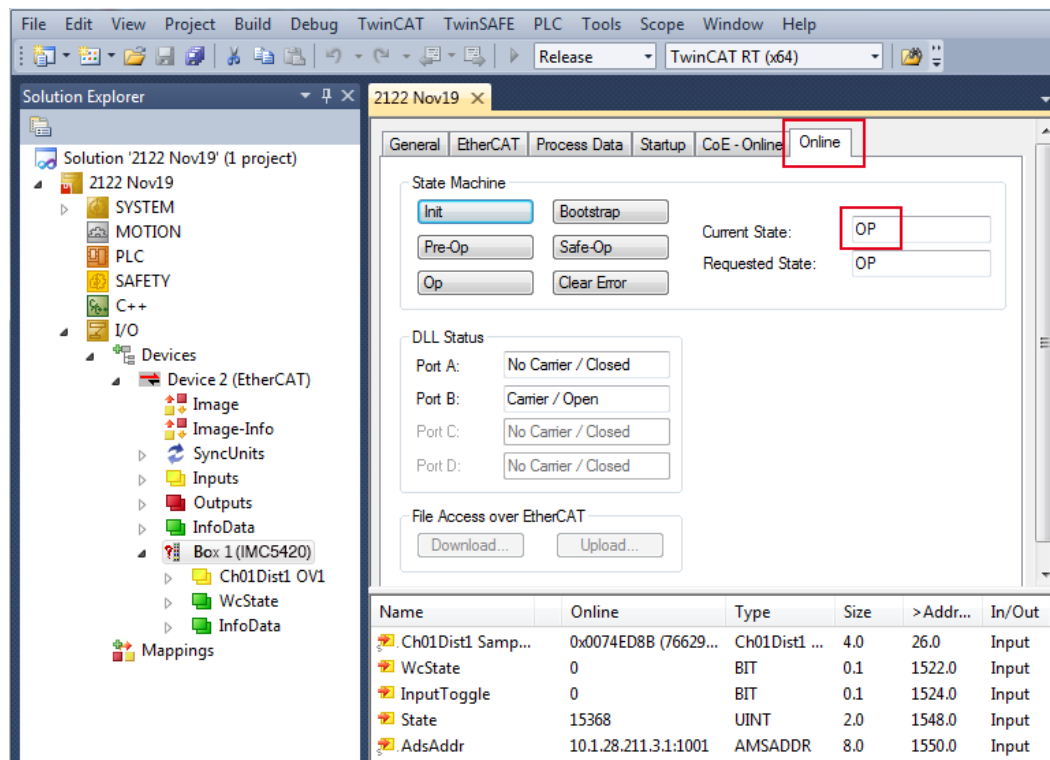

In the event that ERR PREOP appears in Current State the cause is reported in the message window. This is the case if the PDO mapping settings in the controller are different from the settings in the ESI file, see [Chap. A 4.12](#).

The factory settings specify only one measurement (thickness 1) as output value (both in the controller and in the ESI file).

You can select additional data on the Process Data tab.

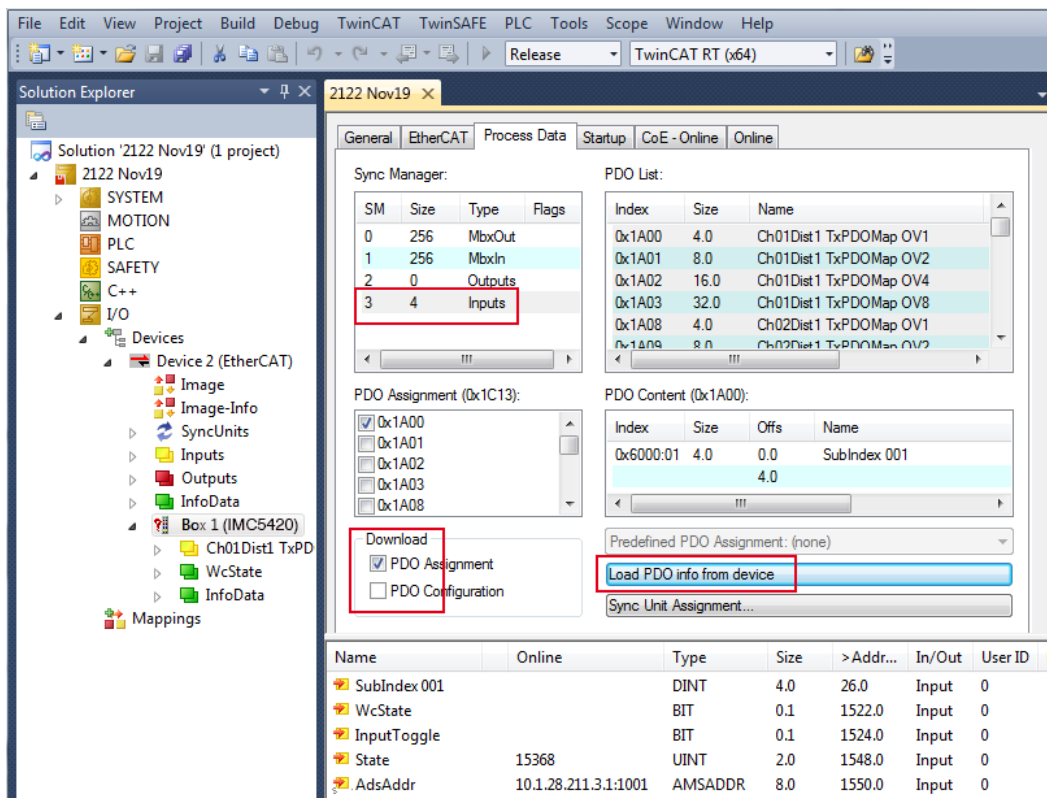

You can now view the scope of available process data and the assignment of sync managers.

▶ From the TwinCAT menu select the Restart TwinCAT (Config Mode) tab.

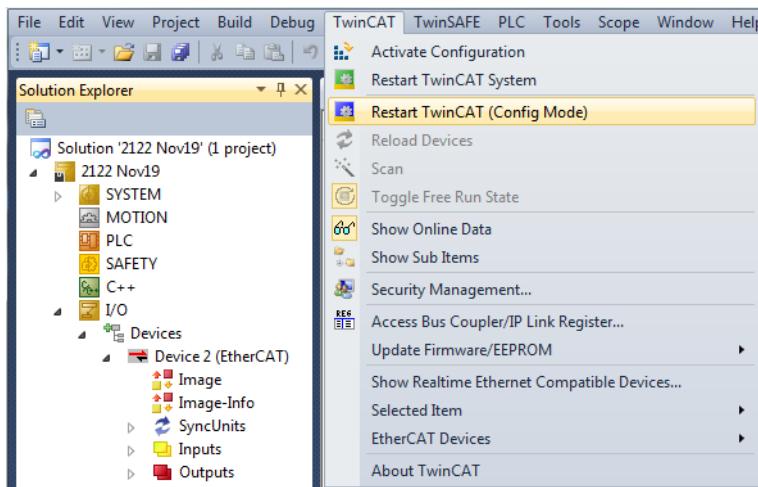

Configuration is now complete.

In the SAFEOP and OP states, the selected measurements are transmitted as process data.

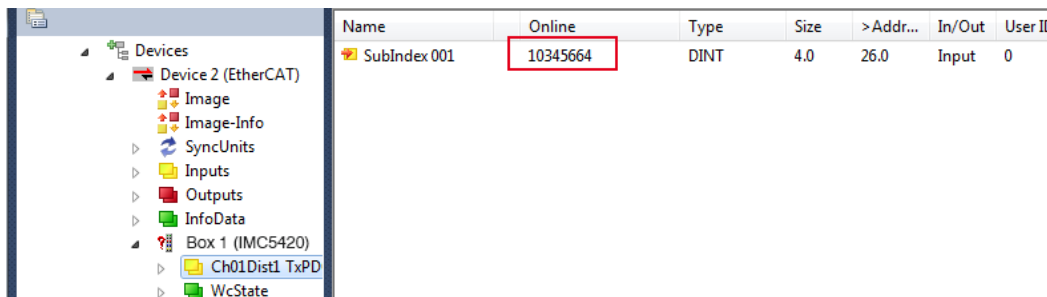

A 5 Data Format RS422

A 5.1 Bit Structure

Description	Bit 7	Bit 6	Bit 5	Bit 4	Bit 3	Bit 2	Bit 1	Bit 0
Data value (measurement value) minimum 2, maximum 5 bytes	1	D6	D5	D4	D3	D2	D1	D0
	1	D13	D12	D11	D10	D9	D8	D7
	1	D20	D19	D18	D17	D16	D15	D14
	1	D27	D26	D25	D24	D23	D22	D21
	0	0	0	0	D31	D30	D29	D28
Footer	0	F	0	EoF	C	DT		O

- Data value

- 14 bits minimum
- 32 bits maximum

- F (Footer followed)

- 0. No additional footer byte
- 1. Additional footer byte

Bit 5 must be 0 to allow for differentiating the footer from the ">" character.

- EoF (End of Frame)

- 0. Additional packet with data from the current frame follows
- 1. Last packet with data from the current frame

- C (Change Bit)

Change of sensor configuration (only RS422 data output). Is automatically reset after output.

- DT (Data type)

- 0. Measurement values
- 1. Video signals (FFT)
- 2. Reserved (Raw)
- 3. Reserved

- O (Overflow)

- 0. No UART overflow
- 1. UART overflow, the data are valid, but data frames are missing

A 5.2 Description

The format consists of one or several data values and a footer, which concludes the data packet. The end of a data value and the footer are coded in the 7th bit of each byte:

- 1 Additional data byte follows
- 0 End of data value or footer.

A bit that has not been set marks the end of the data value. Starting with the second bit that has not been set, the footer follows.

A mix of different bit widths is possible (e.g., 18/32 bit). Video signals can also be transmitted as data values. Measuring signal packets are differentiated from video signal packets via the data type (DT). A video signal is always transmitted in a separate data packet with its own footer. Thus, if there are two video signals + measurement values, three data packets, incl. one footer each, are transmitted. For each measuring frame, several video data packets, but only one measured data packet, can be transmitted. The EoF bit in the footer marks whether the data packet that was just transmitted is the last packet in a continuous measuring frame from the controller.

The minimum bit width to be transmitted is 14 bits, the maximum width is 32 bits. All unused bits are 0. Bit widths are not dynamically changed among several frames. Changes to the data packet or the relevant controller configuration are indicated by the change bit (C). It refers to the measurement frame that has just been received. The change bit is only set for one measurement frame and is automatically reset. If a measurement frame consists of several data packets, the

change bit is set in all footers.

The overflow bit (O) indicates that one or several measurement frame were not transmitted between the current and previous measuring frame. The bit is transmitted only once for each identified loss and is then reset. If a measurement frame consists of several data packets, the overflow bit is set in all footers. If measurement frame are permanently lost, the bit is set permanently.

ASCII replies are only allowed between the last data packet in a measuring frame (EoF bit has been set) and the next data packet.

A 5.3 Examples

Video signal 1

Description	Bit 7	Bit 6	Bit 5	Bit 4	Bit 3	Bit 2	Bit 1	Bit 0
Pixel 1 (14 Bit)	1	D00 ... D06						
	0	D07 ... D13						
Pixel n (14 Bit)	1	D00 ... D06						
	0	D07 ... D13						
Pixel 512 (14 Bit)	1	D00 ... D06						
	0	D07 ... D13						
Footer	0	0	0	0	0	0	1	0

Video signal 2

Description	Bit 7	Bit 6	Bit 5	Bit 4	Bit 3	Bit 2	Bit 1	Bit 0
Pixel 1 (14 Bit)	1	D00 ... D06						
	0	D07 ... D13						
Pixel n (14 Bit)	1	D00 ... D06						
	0	D07 ... D13						
Pixel 512 (14 Bit)	1	D00 ... D06						
	0	D07 ... D13						
Footer	0	0	0	0	0	0	1	0

Measurement values

Description	Bit 7	Bit 6	Bit 5	Bit 4	Bit 3	Bit 2	Bit 1	Bit 0
Measurement value (32 bit)	1	D00 ... D06						
	1	D07 ... D13						
	1	D14 ... D20						
	1	D21 ... D27						
	0	0	0	0	D28 ... D31			
Footer	0	0	0	1	0	0	0	0

ASCII reply:

ECHO OFF\r\n->

Video signal 1:

Description	Bit 7	Bit 6	Bit 5	Bit 4	Bit 3	Bit 2	Bit 1	Bit 0
Pixel 1 (14 bits)	1	D00 ... D06						
	0	D07 ... D13						
Pixel n (14 bits)	1	D00 ... D06						
	0	D07 ... D13						
Pixel 512 (14 bits)	1	D00 ... D06						
	0	D07 ... D13						
Footer	0	0	0	0	0	0	1	0

A 6 Telnet

A 6.1 General

The Telnet service allows you to communicate with the IMS5x00 from your PC. To communicate with Telnet, you will need

- an existing Ethernet connection between IMS5x00 and your PC,
- the ASCII commands, see [A 3](#).

A 6.2 Connection establishment

➤ Start the program `Telnet.exe` via `Start > Run`.

➤ Type in the command `o 192.254.168.150` or the IP address of the controller.

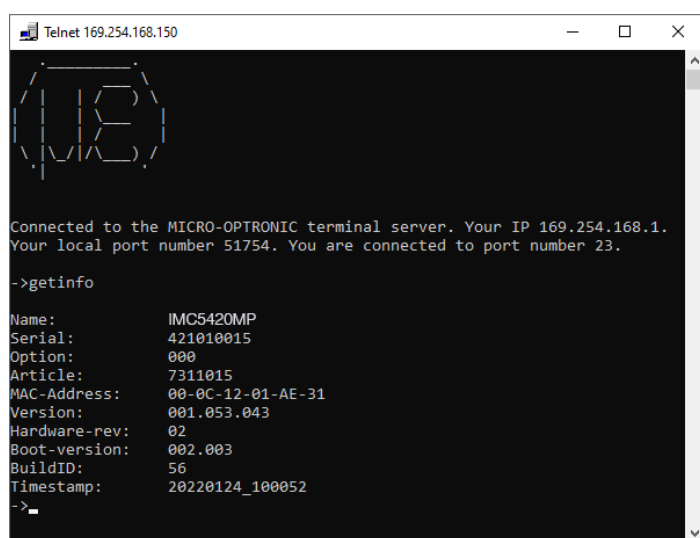

```

Telnet 169.254.168.150
Connected to the MICRO-OPTRONIC terminal server. Your IP 169.254.168.1.
Your local port number 51754. You are connected to port number 23.

->getinfo
Name:          IMC5420MP
Serial:        421010015
Option:        000
Article:       7311015
MAC-Address:   00-0C-12-01-AE-31
Version:       001.053.043
Hardware-rev: 02
Boot-version:  002.003
BuildID:       56
Timestamp:     20220124_100052
->_

```

Fig. 85 Telnet start screen of IMC5420MP

A command always consists of the command name and zero or several parameters that are separated with a space. The currently set parameter value is reset if a command is invoked without parameters.

The output format is:

<Command name> <Parameter1> [<Parameter2> [...]]

The returned command can be used again without changes for setting the password. After a command is processed, a line break and a prompt (“->”) is always returned. In the event of an error, an error message beginning with `Exx`, where `xx` stands for a unique error number, comes before the prompt.

- If no connection is successfully established after the IP address is sent, send a `c` to close the connection. Now send the command `o 192.254.168.150` again to establish the connection..

A 6.3 Error Messages

The following error messages may appear:

- E01 Unknown command: An unknown parameter ID was submitted.
- E06 Access denied: This parameter cannot be accessed at the present time. The controller may not be in Expert mode or the parameter may not be visible due to other settings.
- E08 Unknown parameter: Not enough parameters were submitted.
- E11 The input value is outside the validity range, or the format is invalid: The submitted value is outside the validity range.

The text in the error messages depends on the set language. The error message identifier (E_{xx}) is the same for every language.



MICRO-EPSILON MESSTECHNIK GmbH & Co. KG
Koenigbacher Str. 15 · 94496 Ortenburg/Germany
Phone +49 8542 168 0 · Fax +49 8542 168 90
info@micro-epsilon.com · www.micro-epsilon.com
Your local contact: www.micro-epsilon.com/contact/worldwide/

X9751463-A012054MSC
© MICRO-EPSILON MESSTECHNIK