



More Precision

optoNCDT // Laser displacement sensors (triangulation)





Laser sensors with small laser line / Industrial Ethernet interface optoNCDT 1900LL

- Direct PLC connection without additional module
- High speed data transmission due to oversampling
- Easy handling: Parameter set up via web interface
- Supply possible via PoE
- For shiny metallic, rough and structured surfaces



PROFI
NET

EtherCAT

EtherNet/IP

High-performance laser sensors with small laser line

The optoNCDT 1900LL projects a small laser line onto the measuring object. This compact laser sensor particularly impresses in distance measurements where the sensor or measuring object is moved in the Z-axis direction. optoNCDT 1900LL sensors are designed for shiny metallic and structured surfaces, as well as for measurements of materials where the laser beam penetrates.

For these surfaces, the small laser line offers significant advantages, as it optically averages and compensates for irregularities such as structure and roughness. In addition to optical averaging, special software algorithms filter out interferences caused by surface roughness, defects, depressions or the smallest of holes.

Especially on metals, they achieve more stable and reliable measurement results than point sensors. The integrated Industrial Ethernet interface enables direct integration into the machine or production environment.

The optoNCDT 1900LL is used wherever high precision and reliability are required, e.g., in challenging automation tasks, automotive production, 3D printing and in measuring machines.

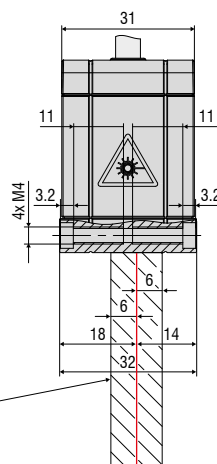
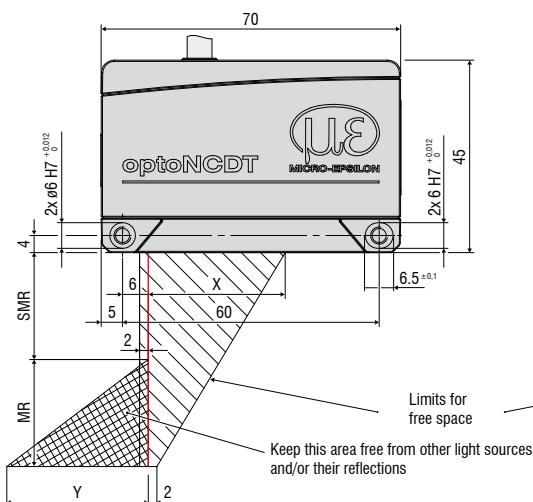

Connector (sensor side)

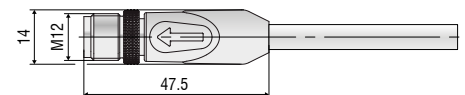

MR	SMR	X	Y
2	15	23	3
6	17	27	9
10	20	33	14
25	25	33	33
50	40	36	45

(dimensions in mm, not to scale)

Model		ILD1900-2LL	ILD1900-6LL	ILD1900-10LL	ILD1900-25LL	ILD1900-50LL
Measuring range		2 mm	6 mm	10 mm	25 mm	50 mm
Start of measuring range		15 mm	17 mm	20 mm	25 mm	40 mm
Mid of measuring range		16 mm	20 mm	25 mm	37.5 mm	65 mm
End of measuring range		17 mm	23 mm	30 mm	50 mm	90 mm
Measuring rate ¹⁾		continuously adjustable between 0.25 ... 10 kHz				
		7 adjustable stages: 10 kHz / 8 kHz / 4 kHz / 2 kHz / 1.0 kHz / 500 Hz / 250 Hz				
Linearity		< ±1 μm	< ±1.2 μm	< ±2 μm	< ±5 μm	< ±10 μm
		< ±0.05 % FSO	< ±0.02 % FSO	< ±0.02 % FSO	< ±0.02 % FSO	< ±0.02 % FSO
Repeatability ²⁾		< 0.1 μm	< 0.25 μm	< 0.4 μm	< 0.8 μm	< 1.6 μm
Temperature stability ³⁾		±0.005 % FSO / K				
Light spot diameter (±10 %) ⁴⁾	SMR	55 x 480 μm	100 x 600 μm	125 x 730 μm	210 x 950 μm	235 μm x 1280 μm
	MMR	40 x 460 μm	50 x 565 μm	55 x 690 μm	80 x 970 μm	125 μm x 1500 μm
	EMR	55 x 440 μm	100 x 525 μm	125 x 660 μm	220 x 1000 μm	325 μm x 1740 μm
	smallest diameter	40 x 460 μm with 16 mm	50 x 565 μm with 20 mm	55 x 690 μm with 25 mm	80 x 970 μm with 37.5 mm	115 x 1450 μm with 59 mm
Light source		Semiconductor laser ≤ 1 mW, 670 nm (red) with laser class 2				
Laser class		Class 2 in accordance with DIN EN 60825-1: 2015-07 Class 3 available on request				
Permissible ambient light		50,000 lx				
Supply voltage		11 ... 30 VDC or PoE				
Power consumption		< 3 W (24 V)				
Signal input		1 x HTL/TTL Laser on/off				
Digital interface		EtherCAT / EtherNet/IP / PROFINET				
Synchronization		possible via fieldbus				
Connector		integrated pigtail 0.3 m with 12-pin M12 plug; optional extension to 3 m / 6 m / 9 m (see accessories for suitable connection cables)				
Temperature range	Storage	-20 ... +70 °C (non-condensing)				
	Operation	0 ... +50 °C (non-condensing)				
Shock (DIN EN 60068-2-27)		15 g / 6 ms in 3 axes				
Vibration (DIN EN 60068-2-6)		30 g / 20 ... 500 Hz				
Protection class (DIN EN 60529)		IP67				
Material		Aluminum housing				
Weight		approx. 185 g (incl. pigtail)				
Control and indicator elements		Select key: factory settings, switching the operation mode web interface for setup ⁵⁾ : application-specific presets, peak selection, video signal, freely selectable averaging possibilities, data reduction, setup management; 1 x color LED for power / status 2 x color LEDs for fieldbus status				

FSO = Full Scale Output

SMR = Start of measuring range, MMR = Mid of measuring range, EMR = End of measuring range

The specified data apply to a white, diffuse reflecting surface (Micro-Epsilon reference ceramic for ILD sensors)

¹⁾ Maximum measuring rate depending on fieldbus and bus cycle time; factory settings: measuring rate 4 kHz, median 9

²⁾ Typical value with measurements at 4 kHz and median 9

³⁾ In the mid of the measuring range; the specified value is only achieved by mounting on a metallic sensor holder.

Good heat dissipation from the sensor to the holder must be ensured.

⁴⁾ Light spot diameter with line-shaped laser determined based on the emulated 90/10 knife-edge method

⁵⁾ Connection to PC via network cable (with EtherCAT: sensor in Ethernet setup mode)

Accessories for all optoNCDT series

Power supply

- PS2020 (power supply 24 V / 2.5 A, input 100 - 240 VAC, output 24 VDC / 2.5 A, mounting onto symmetrical standard rail 35 mm x 7.5 mm, DIN 50022)

Accessories for 1220/1320 series

Protective film

- Transparent protective film 32 x 11 mm for ILD1x20

Accessories for 1420 series

Supply and output cable (drag-chain suitable)

- PCF1420-1/I (1 m, output 4 ... 20 mA)
- PCF1420-1/I(01) (1 m, output 4...20 mA)
- PCF1420-3/I (3 m, output 4 ... 20 mA)
- PCF1420-6/I (6 m, output 4 ... 20 mA)
- PCF1420-10/I (10 m, output 4 ... 20 mA)
- PCF1420-15/I (15 m, output 4 ... 20 mA)
- PCF1420-3/U (3 m, with integrated resistor, output 1 ... 5 VDC)*
- PCF1420-6/U (6 m, with integrated resistor, output 1 ... 5 VDC)*
- PCF1420-10/U (10 m, with integrated resistor, output 1 ... 5 VDC)*
- PCF1420-15/U (15 m, with integrated resistor, output 1 ... 5 VDC)*
- PCF1420-3/IF2008 (3 m, interface and supply cable)
- PCF1420-6/IF2008 (6 m, interface and supply cable)
- PCF1420-10/IF2008 (10 m, interface and supply cable)
- PCF1420-3/C-Box (3 m)

* on request with output 2 ... 10 VDC

Supply and output cable, suitable for use with robots

(available in 90° version)

- PCR1402-3/I (3 m)
- PCR1402-6/I (6 m)
- PCR1402-8/I (8 m)

Protective film

Transparent protective film 32 x 11mm for ILD1x20

Accessories for 1710/1750/1760 series

Supply and output cable (drag-chain suitable)

- PC1700-3 (3 m)
- PC1700-10 (10 m)
- PC1700-10/IF2008 (10 m, for use with interface card IF2008)
- PC1750-3/C-Box (3 m)
- PC1750-6/C-Box (6 m)
- PC1750-9/C-Box (9 m)

Supply and output cable (suitable for use with robots)

- PCR1700-5 (5 m)
- PCR1700-10 (10 m)

Supply and output cables for temperatures up to 200 °C

- PC1700-3/OE/HT (3 m)
- PC1700-6/OE/HT (6 m)
- PC1700-15/OE/HT (15 m)

Protective housings

- SGH model (sizes S and M)
- SGHF model (sizes S and M)
- SGHF-HT model

Accessories for 1900 series

Supply and output cable (drag-chain suitable)

- PC1900-3/IF2008 Supply/output cable 3 m
- PC1900-6/IF2008 Supply/output cable 6 m
- PC1900-9/IF2008 Supply/output cable 9 m
- PC1900-15/IF2008 Supply/output cable 15 m
- PC1900-3/C-Box Power/output cable 3 m
- PC1900-6/C-Box Power/output cable 6 m
- PC1900-9/C-Box Power/output cable 9 m
- PC1900-15/C-Box Power/output cable 15 m
- PC1900-3/OE Supply/output cable 3 m
- PC1900-6/OE Supply/output cable 6 m
- PC1900-9/OE Supply/output cable 9 m
- PC1900-15/OE Supply/output cable 15 m
- PC1900-IE-3/OE-RJ45 Ethernet cable 3 m
- PC1900-IE-6/OE-RJ45 Ethernet cable 6 m
- PC1900-IE-9/OE-RJ45 Ethernet cable 9 m
- PC1900-IE-3/RJ45 Ethernet cable 3 m
- PC1900-IE-6/RJ45 Ethernet cable 6 m
- PC1900-IE-9/RJ45 Ethernet cable 9 m

Protective film

- Transparent protective film 52 x 15 mm for ILD1900

Accessories for 2300/2310 series

Supply and output cable

- PC2300-0,5Y (connection cable to PC or PLC; for operation a PC2300-3/SUB-D will be required in addition)
 - PC2300-3/SUB-D (3 m; for operation a PC2300-0,5Y will be required in addition)
 - PC2300-3/IF2008 (interface and supply cable)
 - PC2300-3/OE (3 m)
 - PC2300-6/OE (6 m)
 - PC2300-9/OE (9 m)
 - PC2300-15/OE (15 m)
 - PC2300-3/C-Box/RJ45 (3 m)
- * other cable lengths on request

Supply and output cables for temperatures up to 200 °C

- PC2300-3/OE/HT (3 m)
- PC2300-6/OE/HT (6 m)
- PC2300-9/OE/HT (9 m)
- PC2300-15/OE/HT (15 m)

Protective housings

- SGH model (sizes S and M)
- SGHF model (sizes S and M)
- SGHF-HT model

sensorTOOL

The Micro-Epsilon sensorTOOL is a powerful software that is used to operate one or more optoNCDT sensors. The sensorTOOL can be used to access the sensor connected to the PC, display its complete data stream and save it in a file (in Excel-compatible CSV format). The sensor is configured via its web interface.

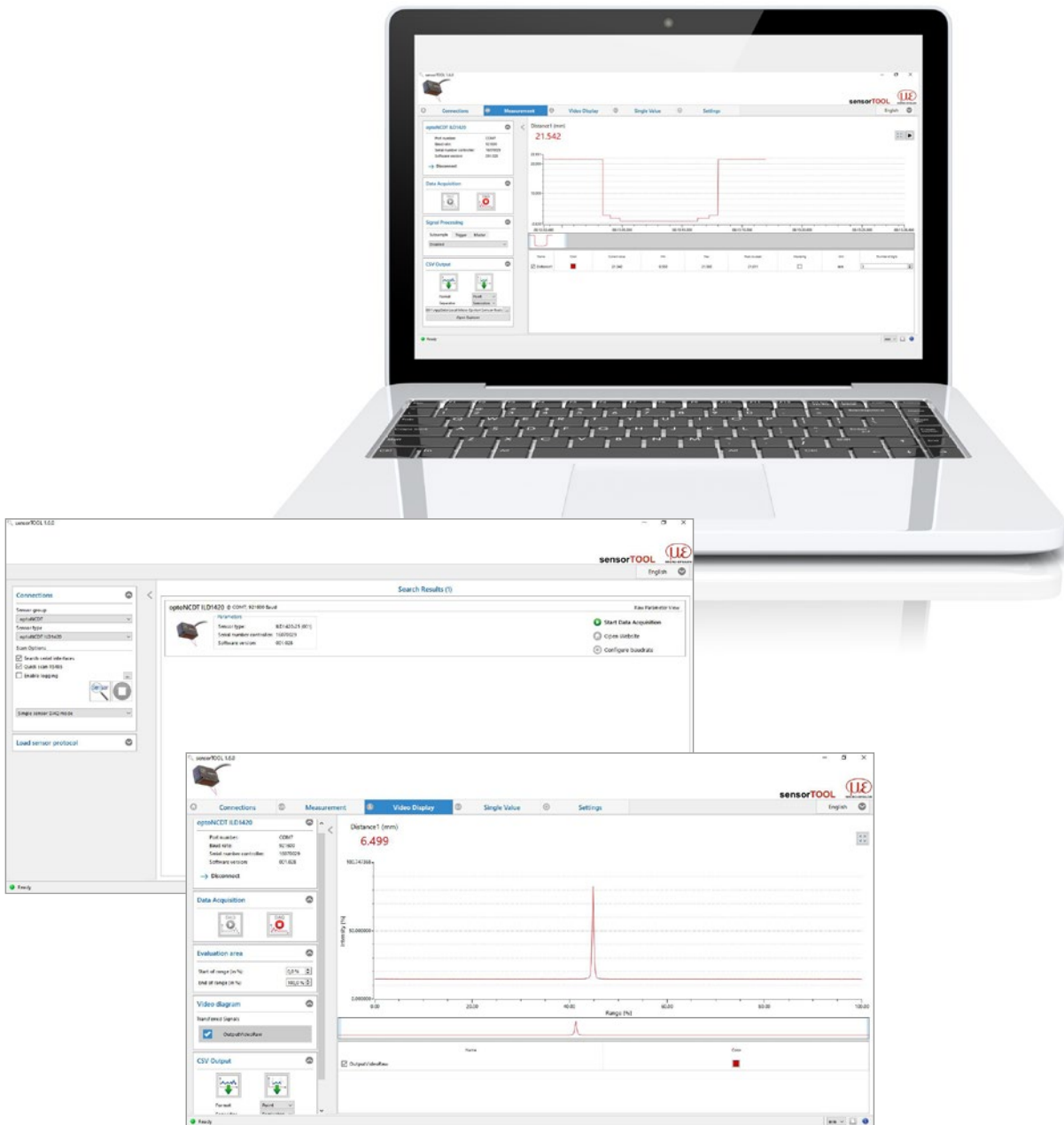

Free download

All software tools, drivers and documented driver DLL for easy integration of the sensors into existing or internally-generated software are available free of charge under www.micro-epsilon.de/download

Accessories

optoNCDT

Protective housings for demanding environments

To protect the optoNCDT laser sensors in harsh environments, protective housings are available in different designs.

SGH model:

The SGH protective housing encloses the sensor and is equipped with a replaceable protective window. The water-resistant housing protects the sensor from solvents and detergents.

Size S for the following models:

- 1750-20BL and 1750-200BL
- 2300-2, 2300-5, 2300-10, 2300-20, 2300-50 and 2300-100
- 2300-2LL, 2300-10LL, 2300-20LL and 2300-50LL
- 2300-2BL, 2300-5BL and 2300-10BL

Size M for the following models:

- 1750-500BL and 1750-750BL
- 1750-500 and 1750-750
- 2300-200 and 2300-300
- 2310-10, 2310-20 and 2310-40

SGHF model:

With window and compressed-air connection ideal for high ambient temperatures. The integrated air cooling of the housing offers optimum protection for the sensor.

Size S for the following models:

- 1750-20BL and 1750-200BL
- 2300-2, 2300-5, 2300-10, 2300-20, 2300-50 and 2300-100
- 2300-2LL, 2300-10LL, 2300-20LL and 2300-50LL
- 2300-2BL, 2300-5BL and 2300-10BL

Size M for the following models:

- 1750-500BL and 1750-750BL
- 1750-500 and 1750-750
- 2300-200 and 2300-300
- 2310-10, 2310-20 and 2310-40

SGHF-HT model:

This water-cooled protective housing with window and compressed-air connection is designed for measurement tasks in ambient temperatures up to 200 °C.

For the following models:

- 1710-50 and 1710-1000
- 1710-50BL and 1710-1000BL
- 1750-500 and 1750-750
- 1750-500BL and 1750-750BL
- 2300-200 and 2300-300
- 2310-50BL
- 2310-10, 2310-20, 2310-40 and 2310-50

Maximum temperature of cooling water $T(\max) = 10\text{ °C}$

Minimum water flow rate $Q(\min) = 3\text{ liters/min}$



SGH size S (140 x 140 x 71 mm)



SGH size M (180 x 140 x 71 mm)



SGHF size S (140 x 140 x 71 mm)



SGHF size M (180 x 140 x 71 mm)



SGHF-HT (260 x 180 x 154 mm)

Interface modules

Module	optoNCDT 1220	optoNCDT 1320	optoNCDT 1420	optoNCDT 1710	optoNCDT 1750	optoNCDT 1900	optoNCDT 2300	optoNCDT 2310
C-Box/2A Controller unit for evaluation and signal conversion of up to 2 sensor signals	⊘	⊘	✓	⊘	✓	✓	✓	✓
IF2001/USB RS422/USB converter to transform a digital signal to USB	✓	✓	✓	✓	✓	✓	✓	✓
IC2001/USB Single-channel RS422/USB converter cable	✓	✓	✓	✓	✓	✓	✓	✓
IF2004/USB RS422/USB converter to convert up to 4 digital signals to USB	⊘	⊘	✓	✓	✓	✓	✓	✓
IF2008/ETH Interface module for Ethernet connection for up to 8 sensors	⊘	⊘	✓	⊘	✓	✓	✓	✓
IF2008PCIE Interface card for multiple sensor signals; analog and digital interfaces	⊘	⊘	✓	✓	✓	✓	✓	✓
IF2030/PNET Interface module for Industrial Ethernet connection (PROFINET)	✓	✓	✓	⊘	✓	✓	✓	✓
IF2030/ENETIP Interface module for Industrial Ethernet connection (EtherNet/IP)	✓	✓	✓	⊘	✓	✓	✓	✓

C-Box/2A Controller for D/A conversion and evaluation of up to 2 sensor signals

C-Box/2A is used for fast D/A conversion of two digital input signals or for evaluating two digital sensor signals. The controller is compatible with the optoNCDT 1420, 1750, 1900 and 2300 models. Handling of the C-Box/2A and of the connected sensors are performed via web interface. Averaging functions, thickness, diameter, step and inclinations can be calculated. The D/A conversion is executed at 16 bit and max. 70 kHz.



Special features

- Trigger input
- Multi-function output
- Measurement value output via Ethernet, USB, analog output 4 ... 20 mA / 0 ... 5 V / 0 ... 10 V / ± 5 V / ± 10 V (scalable via web interface)
- 2x switching outputs for sensors or C-Box/2A status
- Parallel data output via three output interfaces

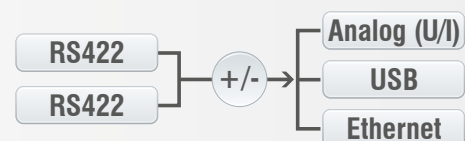

IF2030

Interface module for Industrial Ethernet connection

The IF2030 interface modules are designed for easy connection of Micro-Epsilon sensors to Ethernet-based fieldbuses, e.g., plant control systems. The PROFINET and Ethernet/IP modules are compatible with sensors that output data via an RS422 or RS485 interface. These modules operate on the sensor side with up to 4 MBd and have two network connections for different network topologies. Installation in control cabinets is via a DIN rail.



EtherNet/IP[®]

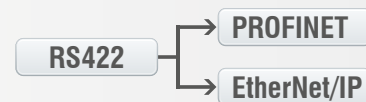

IF2008PCIe/IF2008E

Interface card for synchronous data acquisition

Absolute synchronous data acquisition is a decisive factor for the planarity or thickness measurement using several laser sensors. The IF2008PCIe interface card is designed for installation in PCs and enables the synchronous capture of four digital sensor signals and two encoders. The data is stored in a FIFO memory in order to enable resource-saving processing in blocks in the PC. The IF2008E expansion board enables to detect in addition two digital sensor signals, two analog sensor signals and eight I/O signals.

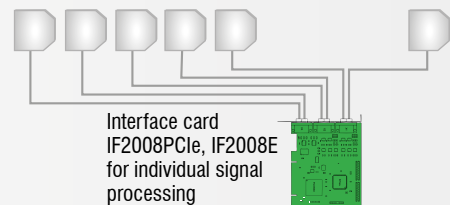
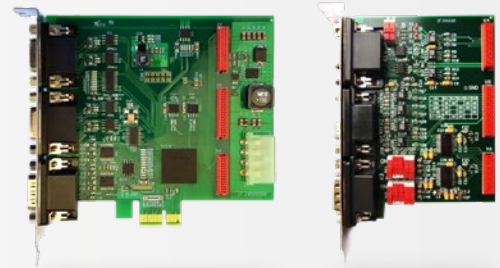

Special features

- IF2008PCIe - Basic printed circuit board: 4 digital signals and 2 encoders
- IF2008E - Expansion board: 2x digital signals, 2x analog signals and 8x I/O signals

IF2008/ETH

IF2008/ETH Interface module for Ethernet connection with up to 8 sensors

The IF2008/ETH integrates up to eight sensors and/or encoders with an RS422 interface into an Ethernet network. Four programmable switching in-/outputs (TTL and HTL logic) are available. Ten indicator LEDs directly on the module show both the channel and the device status. In addition, acquisition and output of data via Ethernet is in addition performed at high speeds up to 200 kHz. Parameter setting of the interface module can be easily done via the web interface.



IC2001/USB Single-channel converter cable RS422/USB

The IC2001/USB single-channel converter cable is used for the USB connection of optoNCDT sensors equipped with an RS422 interface. The cable is easy to assemble and can therefore also be used for installation in machines and systems.

Special features

- 5-core interface cable without outer shield
- Conversion from RS422 to USB
- Easy sensor connection via USB
- Supports baud rates from 9.6 kBaud to 1 MBaud



IF2001/USB converter RS422 to USB

The RS422/USB converter transforms digital signals from a laser-optical sensor into a USB data packet. The sensor and the converter are connected via the RS422 interface of the converter.

Data output is done via USB interface. The converter loops through further signals and functions such as laser on/off, switch signals and function output. The connected sensors and the converter can be programmed through software.

Special features

- Robust aluminum housing
- Easy sensor connection via screw terminals (plug and play)
- Conversion from RS422 to USB
- Supports baud rates from 9.6 kBaud to 12 MBaud

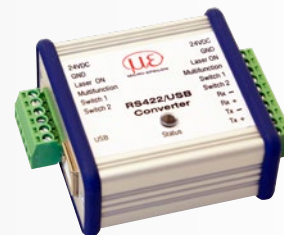

IF2004/USB: 4-channel converter from RS422 to USB

The RS422/USB converter is used for transforming digital signals from up to four optical sensors into USB data signals. The converter has four trigger inputs and a trigger output for connecting additional converters. Data is output via an USB interface. The connected sensors and the converter can be programmed through software.

Special features

- 4x digital signals via RS422
- 4x trigger inputs, 1x trigger output
- Synchronous data acquisition
- Data output via USB

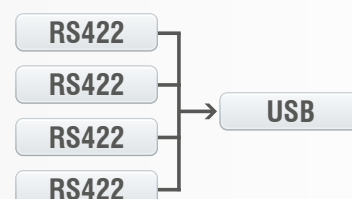

Sensors and Systems from Micro-Epsilon



Sensors and systems for displacement, distance and position



Sensors and measurement devices for non-contact temperature measurement



Measuring and inspection systems for metal strips, plastics and rubber



Optical micrometers and fiber optics, measuring and test amplifiers



Color recognition sensors, LED analyzers and inline color spectrometers



3D measurement technology for dimensional testing and surface inspection